



# CONTENTS 目录

舰船装备 出类拔萃 海联产品 情联四海

## ★ 门类 DOOR

0.门和窗的开启方向和定义 OPENING DEFINITION FOR DIRECTION OF DOOR AND WINDOW .....	001	18. (舱室B型) A60风雨密气密门 (单、双) (TYPE B FOR CABIN)A60 WEATHERTIGHT AND GASTIGHT DOOR(SINGLE/DOUBLE) .....	020
1.船用风雨密单扇钢质门 MARINE WEATHERTIGHT SINGLE-LEAF STEEL DOOR .....	002-005	19.驾驶室移门 SLIDING DOOR FOR WHEELHOUSE .....	021
2.钢质快开闭风雨密(水密)门 STEEL QUICK ACTION WEATHERTIGHT/WATERTIGHT DOOR .....	006	20. 不锈钢/铝质单扇舱室移门 STAINLESS STEEL/ALUMINIUM SINGLE-LEAF SLIDING DOOR FOR CABIN .....	022
3.快开闭风雨密钢质门(埋入式) QUICK OPEN&CLOSE WEATHERTIGHT STEEL DOOR(FLUSH TYPE) .....	007	21. 不锈钢/铝质舱室双扇移门 STAINLESS STEEL/ALUMINIUM DOUBLE-LEAF SLIDING DOOR FOR CABIN .....	023
4.快开闭风雨密钢质门(圆盘式) QUICK OPEN&CLOSE WEATHERTIGHT STEEL DOOR(HAND WHEEL TYPE) .....	008	22. 铝质驾驶室防风雨移门 ALUMINIUM ALLOY SPRAYTIGHT SLIDING DOOR FOR WHEELHOUSE .....	024
5.钢质双扇快开闭风雨密门 STEEL DOUBLE-LEAF QUICK ACTION WEATHERTIGHT DOOR .....	009	23. 铝质/不锈钢风雨密外围壁门 (单、双) ALUMINIUM /STAINLESS STEEL WEATHERTIGHT DOOR FOR WEATHER WALL(S/D) .....	025
6.钢质耐压水密门 STEEL PRESSURE RESISTANT WATERTIGHT DOOR .....	010	24. 玻璃钢风雨密门 GRP WEATHERTIGHT DOOR .....	026
7.钢质耐高压水密门 STEEL HIGH PRESSURE RESISTANT WATERTIGHT DOOR .....	011	25. A60防火移门 A60 FIREPROOF SLIDING DOOR .....	027
8.A60钢质耐压水密门 A60 STEEL PRESSURE RESISTANT WATERTIGHT DOOR .....	011	26. H120防火移门 H120 FIREPROOF SLIDING DOOR .....	028
9.船用风雨密单扇铝质门 MARINE WEATHERTIGHT SINGLE-LEAF ALUMINIUM DOOR .....	012	27. 单扇防火门 SINGLE LEAF FIREPROOF DOOR .....	029-030
10.快开闭风雨密铝质门 QUICK OPEN&CLOSE WEATHERTIGHT ALUMINIUM DOOR .....	013	28. A级带方窗/消防小门防火门 CLASS A FIREPROOF DOOR WITH SQUARE WINDOW/HOSE PORT .....	031
11.A60快开闭风雨密钢质门 (单、双) A60 QUICK OPEN&CLOSE WEATHERTIGHT STEEL DOOR(SINGLE/DOUBLE) .....	014	29. B15级防火门 (带窗和逃生口) B15 FIREPROOF DOOR WITH WINDOW AND EMERGENCY EXIT .....	032
12.A60快开闭风雨密钢质门 A60 QUICK OPEN&CLOSE WEATHERTIGHT STEEL DOOR .....	015	30. A60级双扇防火门 (带消防小门) A60 CLASS DOUBLE LEAVES FIREPROOF DOOR(WITH SMALL FIRE FIGHTING DOOR) .....	033
13. A0快开闭风雨密钢质门 (带窗) A0 QUICK OPEN&CLOSE WEATHERTIGHT STEEL DOOR(WITH WINDOW) .....	016	31 H30b 铝质防火门 H30b ALUMINIUM FIREPROOF DOOR .....	034
14. H120防火快开闭风雨密门 H120 FIREPROOF QUICK OPEN&CLOSE WEATHERTIGHT DOOR .....	016	32. A0,A30级防火防盗门 A0,A30 FIREPROOF ANTI-THEFT DOOR .....	035
15. A60 级单扇钢质防火水密门 (带小门) A60 STEEL SINGLE-LEAF WATERTIGHT DOOR(WITH SMALL DOOR) .....	017	33.钢质隔音阻气门 STEEL SOUNDPROOF GAS- RETARDING DOOR .....	036
16. 气密门 GASTIGHT DOOR .....	018	34.铝质舱室空腹门 ALUMINIUM HOLLOW CABIN DOOR .....	037
17. (舱室A型) A60风雨密气密门 (单、双) (TYPE A FOR CABIN) A60 WEATHERTIGHT AND GASTIGHT DOOR(SINGLE/DOUBLE) .....	019		



# CONTENTS 目录

舰船装备 出类拔萃 海联产品 情联四海

35. 钢质隔声门 STEEL SOUND PROOF DOOR .....	262WHL009G-00	038
36. 铝质隔声门 ALUMINIUM SOUND PROOF DOOR .....	262WHL009A/T-00	039
37. A0隔声防火门 A0 SOUND & FIRE PROOF DOOR .....	262WHL009F-00	040
38. H120防火门 H120 FIREPROOF DOOR .....	262WHL006H-00	041
39. A60 级带逃出口通风栅防火门 A60 CLASS FIREPROOF DOOR WITH ESCAPE & VENTILATION FENCE .....	262WHL005T-00	042
40. 液压滑动式水密门 HYDRAULIC SLIDING WATERTIGHT DOOR .....	262WHL094-00 (符合CB/T3007-2000)	043
41. A60液压滑动式水密门 A60 HYDRAULIC SLIDING WATERTIGHT DOOR .....	262WHL073-00	044
42. 液压铰链式水密门 HYDRAULIC HINGED WATERTIGHT DOOR .....	262WHL100-00	045
43. A0电梯层门(旁开双折) A0 LANDING DOOR FOR ELEVATOR(TWO PANELS SIDE) .....	262WHL071-00	046
44. A0 电梯层门(中分) A0 LANDING DOOR FOR ELEVATOR(CENTRE) .....	262WHL072-00	047

## ★窗类 WINDOW

1. 船用舷窗 SIDE SCUTTLES FOR SHIPS .....	GB/T 14413-1993	048-056
2. 船用普通矩形窗 MARINE ORDINARY RECTANGULAR WINDOW .....	GB/T 5746-2001	057-060
3. 驾驶室固定矩形窗 FIXED RECTANGULAR WINDOW FOR WHEELHOUSE .....	CB/T 3226-1995	061
4. 驾驶室电加热玻璃温控系统* TEMPERATURE CONTROL SYSTEM FOR HEATING GLASSES IN WHEELHOUSE .....		062
5. 铝质移窗 ALUMINIUM SLIDING WINDOW .....	CB/T 3765-1996	063
6. 铝合金中空玻璃隔声窗 ALUMINIUM ALLOY SOUNDPROOF WINDOW .....	CB/T 3917-2011	064
7. 铝质衡力升降式船用窗 ALUMINIUM BALANCED LIFT MARINE WINDOW .....	CB/T 3755-1995	065

8. 带风暴盖内开侧铰链铝质矩形窗 ALUMINIUM INWARD SIDE-HINGED RECTANGULAR WINDOW WITH DEADLIGHT .....	261WHL057-00	065
9. 阻火型服务窗 FIRE RESISTANCE SERVICE WINDOW .....	CB* 3288-1987	066
10. A15 防火服务窗 A15 FIREPROOF SERVICE WINDOW .....	261WHL028-00	067
11. A0级防火卷帘窗 A0 ROLL-UP FIRE WINDOW .....	261WHL080-00	068
12. A0级防火舷窗 A0 CLASS FIREPROOF SIDE SCUTTLE .....	261WHL 065/506-00	069
13. A60级防火舷窗 A60 CLASS FIREPROOF SIDE SCUTTLE .....	261WHL061-00	069
14. A60焊接式开启舷窗 A60 CLASS WELDED HINGED SIDE SCUTTLE .....	261WHL073-00	070
15. A0级防火矩形窗 A0 CLASS FIRE RETARDING RECTANGULAR WINDOW .....	261WHL062/063-00	071
16. A0级防火开式矩形窗 A0 CLASS FIREPROOF OPEN TYPE RECTANGULAR WINDOW .....	261WHL064-00	072
17. A60级高隔声防火窗 A60 FIREPROOF HIGH SOUND-REDUCTION WINDOW .....	261WHL069-00	073
18. A60级防火矩形窗 A60 CLASS FIREPROOF RECTANGULAR WINDOW .....	261WHL059X-00	074
19. A60级防火矩形窗 A60 CLASS FIREPROOF RECTANGULAR WINDOW .....	261WHL059(I)-00	075
20. A60级防火开式矩形窗 A60 CLASS FIRE-PROOF OPEN TYPE RECTANGULAR WINDOW .....	261WHL067-00	075
21. H120级防火矩形窗 H120 CLASS FIRE PROTECTION RECTANGULAR WINDOW .....	261WHL509-00	076
22. 铝质、钢质、不锈钢窗斗ALUMINIUM,STEEL ,STAINLESS STEEL WINDOW BOX 矩形窗斗WINDOW BOX FOR RECTANGULAR WINDOW 舷窗窗斗WINDOW BOX FOR SIDE SCUTTLES	261WHL011-01 261WHL011-09	077 077



# CONTENTS 目录

舰船装备 出类拔萃 海联产品 情联四海

## ★ 盖类 COVER

1. 船用人孔盖 MANHOLE COVERS FOR SHIP .....	CB/T 19-2001	078-079
2. 铝质人孔盖 ALUMINIUM MANHOLE COVER .....	263WHL026-00	080-081
3. 钢质小型舱口盖 STEEL SMALL HATCH COVER .....	CB/T 3728-1995	082-087
4. 转动式油舱盖 ROTATING OILTIGHT HATCH COVER .....	CB/T 282-94	088
5. 快速启闭水密舱口盖 QUICK OPEN&CLOSE WATERTIGHT HATCH COVER .....	CB/T 3842-2000	089
6. 铝质水密舱口盖 ALUMINIUM WATERTIGHT HATCH COVER .....	CB732-68	090
7. 铝质埋入式水密舱口盖 ALUMINIUM SUNK WATERTIGHT HATCH COVER .....	CB958-80	091
8. A15防火舱口盖 A15 FIREPROOF HATCH COVER .....	263WHL001F-00	092
9. A60级埋入式水密舱口盖 A60 FIREPROOF HATCH COVER(SUNK TYPE,WATERTIGHT) .....	263WHL701-00	092

## ★ 梯类 LADDER

1. 铝管直梯 ALUMINIUM PIPE VERTICAL LADDER .....	CB/T 670-94	093
2. 不锈钢直梯 STAINLESS STEEL VERTICAL LADDER .....	267WHL003-00	093
3. 铝质斜梯 ALUMINIUM INCLINED LADDER .....	CB 738-77	094
4. 不锈钢斜梯 STAINLESS STEEL INCLINED LADDER .....	267WHL002-00	094
5. 铝质跳板 ALUMINIUM ALLOY WHARF LADDER .....	CB*3116-82	095

## ★ 屏蔽类 ELECTROMAGNETIC SHIELDING PRODUCT

### \* 门系列 SERIES OF DOORS

0. 舰船用电磁屏蔽门 ELECTROMAGNETIC SHIELDING DOOR FOR NAVAL SHIPS .....	( CB 1337-98 ) *	096-097
1. 标准1级电磁屏蔽门 ( HL-PB-A1型 ) CLASS 1 ELECTROMAGNETIC SHIELDING DOOR(HL-PB-A1) .....	262WHL026A1(II)-00	098
2. 标准2级电磁屏蔽门 ( HL-PB-A2型 ) CLASS 2 ELECTROMAGNETIC SHIELDING DOOR(HL-PB-A2) .....	262WHL026A2(II)-00	098
3. 标准3级电磁屏蔽门 ( HL-PB-A3型 ) CLASS 3 ELECTROMAGNETIC SHIELDING DOOR(HL-PB-A3) .....	262WHL026A3(II)-00	099
4. 防火型1级电磁屏蔽门 ( HL-PB-B1型 ) FIREPROOF CLASS 1 ELECTROMAGNETIC SHIELDING DOOR(HL-PB-B1) .....	262WHL026B1(II)-00	099
5. 防火型2级电磁屏蔽门 ( HL-PB-B2型 ) FIREPROOF CLASS 2 ELECTROMAGNETIC SHIELDING DOOR(HL-PB-B2) .....	262WHL026B2(II)-00	100
6. 防火型3级电磁屏蔽门 ( HL-PB-B3型 ) FIREPROOF CLASS 3 ELECTROMAGNETIC SHIELDING DOOR(HL-PB-B3) .....	262WHL026B3(II)-00	100
7. 风雨密1级电磁屏蔽门 ( HL-PB-D1型 ) WEATHERTIGHT CLASS 1 ELECTROMAGNETIC SHIELDING DOOR(HL-PB-D1) .....	262WHL026D1(II)-00	101
8. 风雨密2级电磁屏蔽门 ( HL-PB-D2型 ) WEATHERTIGHT CLASS 2 ELECTROMAGNETIC SHIELDING DOOR(HL-PB-D2) .....	262WHL026D2(II)-00	101
9. 铝质1级电磁屏蔽门 ( HL-PB-L1型 ) ALUMINIUM CLASS 1 ELECTROMAGNETIC SHIELDING DOOR(HL-PB-L1) .....	262WHL025L1(II)-00	102
10. 铝质2级电磁屏蔽门 ( HL-PB-L2型 ) ALUMINIUM CLASS 2 ELECTROMAGNETIC SHIELDING DOOR(HL-PB-L2) .....	262WHL025L2(II)-00	102
11. 铝质3级电磁屏蔽门 ( HL-PB-L3型 ) ALUMINIUM CLASS 3 ELECTROMAGNETIC SHIELDING DOOR(HL-PB-L3) .....	262WHL025L3(II)-00	103
12. H30b铝质防火1级电磁屏蔽门 ( HL-PB-LB130型 ) H30b ALUMINIUM FIREPROOF CLASS 1 ELECTROMAGNETIC SHIELDING DOOR (HL-PB-LB130) .....	262WHL025LB1(30)-00	103
13. H30b铝质防火2级电磁屏蔽门 ( HL-PB-LB230型 ) H30b ALUMINIUM FIREPROOF CLASS 2 ELECTROMAGNETIC SHIELDING DOOR (HL-PB-LB230) .....	262WHL025LB2(30)-00	104
14. H30b铝质防火3级电磁屏蔽门 ( HL-PB-LB330型 ) H30b ALUMINIUM FIREPROOF CLASS 3 ELECTROMAGNETIC SHIELDING DOOR (HL-PB-LB330) .....	262WHL025LB3(30)-00	104
15. 带通风栅标准1级电磁屏蔽门 ( HL-PB-TA1型 ) CLASS 1 ELECTROMAGNETIC SHIELDING DOOR WITH VENTILATION FENCE (HL-PB-TA1) .....	262WHL024TA1(II)-00	105



# CONTENTS 目录

舰船装备 出类拔萃 海联产品 情联四海

16. 带通风栅标准2级电磁屏蔽门 ( HL-PB-TA2型 ) CLASS 2 ELECTROMAGNETIC SHIELDING DOOR WITH VENTILATION FENCE (HL-PB-TA2) .....	262WHL024TA2(II)-00 105
17. 带通风栅标准3级电磁屏蔽门 ( HL-PB-TA3型 ) CLASS 3 ELECTROMAGNETIC SHIELDING DOOR WITH VENTILATION FENCE (HL-PB-TA3) .....	262WHL024TA3(II)-00 106
18. 带通风栅铝质1级电磁屏蔽门 ( HL-PB-TL1型 ) ALU. CLASS 1 ELECTROMAGNETIC SHIELDING DOOR WITH VENTILATION FENCE (HL-PB-TL1) .....	262WHL024TL1(II)-00 106
19. 带通风栅铝质2级电磁屏蔽门 ( HL-PB-TL2型 ) ALU. CLASS 2 ELECTROMAGNETIC SHIELDING DOOR WITH VENTILATION FENCE (HL-PB-TL2) .....	262WHL024TL2(II)-00 107
20. 带通风栅铝质3级电磁屏蔽门 ( HL-PB-TL3型 ) ALU. CLASS 3 ELECTROMAGNETIC SHIELDING DOOR WITH VENTILATION FENCE (HL-PB-TL3) .....	262WHL024TL3(II)-00 107
21. 铝质隐身风雨密电磁屏蔽门 ( HL-PB-LE型 ) ALU. STEALTH WEATHERTIGHT ELECTROMAGNETIC SHIELDING DOOR (HL-PB-LE) .....	262WHL025LE1-00 108
22. A60防火电磁屏蔽门 A60 ELECTROMAGNETIC SHIELDING DOOR .....	262WHL027F60-00 108
23. A60铝质1级电磁屏蔽门 A60 ALUMINIUM CLASS 1 ELECTROMAGNETIC SHIELDING DOOR	262WHL030B1-00
24. A60铝质1级电磁屏蔽门 A60 ALUMINIUM CLASS 2 ELECTROMAGNETIC SHIELDING DOOR	262WHL030B2-00

## \*窗系列 SERIES OF WINDOWS

0. 舰船用电磁屏蔽窗 ELECTROMAGNETIC SHIELDING WINDOW FOR NAVAL SHIPS .....	109
1. 开式 ( S ) 型1级电磁屏蔽窗 HINGED(TYPE S) CLASS 1 ELECTROMAGNETIC SHIELDING WINDOW .....	261WHL028BK-00 110
2. 闭式 ( G ) 型1级电磁屏蔽窗 FIXED(TYPE G) CLASS 1 ELECTROMAGNETIC SHIELDING WINDOW .....	261WHL028BG-00 110
3. 开式 ( S ) 型2级电磁屏蔽窗 HINGED(TYPE S) CLASS 2 ELECTROMAGNETIC SHIELDING WINDOW .....	261WHL028AK-00 111
4. 闭式 ( G ) 型2级电磁屏蔽窗 FIXED(TYPE G) CLASS 2 ELECTROMAGNETIC SHIELDING WINDOW .....	261WHL028AG-00 111
5. 电磁屏蔽玻璃窗(焊接式) ELECTROMAGNETIC SHIELDING GLASS WINDOW(WELDED) .....	261WHL068-00 112

6. X光屏蔽窗 X RAY SHIELDING WINDOW .....	261WHL067-00 112
7. 隐身固定矩形窗 STEALTH FIXED RECTANGULAR WINDOW .....	261WHL003-00 113

## \*盖系列 SERIES OF COVER

1. A60钢质防火风雨密屏蔽盖 A60 STEEL WEATHERTIGHT ELECTROMAGNETIC SHIELDING COVER .....	263WHL030B-00 114
2. 铝质电磁屏蔽盖 ALUMINIUM ELECTROMAGNETIC SHIELDING COVER .....	263WHL030-00 115

## \*通风配件 DRAFT FITTINGS

1. 电磁屏蔽通舱管件 ELECTROMAGNETIC SHIELDING PIPE PENETRATING PIECES .....	545WHL001-00 116
2. 电磁屏蔽通风栅 ELECTROMAGNETIC SHIELDING VENTILATION FENCE .....	545WHL002-00 116



## 门和窗的开启方向定义 OPENING DEFINITION FOR DIRECTION OF DOOR AND WINDOW

1. 门开启方向的定义  
DEFINITION FOR DOOR OPEN DIRECTION  
门的开启方向, 从室外向室内看, 铰链在左边的为左开门, 铰链在右边的为右开门, 其开启方向如下图所示, 代号见下表。  
LOOKING FROM OUTSIDE, THE DOOR WITH HINGE ON THE LEFT (RIGHT) SIDE CALLED LEFT (RIGHT) OPENING DOOR. THE OPENING DIRECTION INDICATED AS FIGURE. THE CODE INDICATED AS LISTED.

门的开启方向 OPENING DIRECTION OF DOOR	特征代号 CODE
左内开 LEFT INWARD OPENING	5.0 (LI)
左外开 LEFT OUTWARD OPENING	6.1 (LO)
右内开 RIGHT INWARD OPENING	6.0 (RI)
右外开 RIGHT OUTWARD OPENING	5.1 (RO)

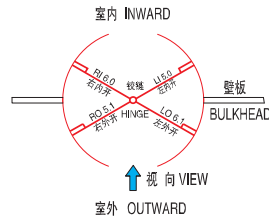

2. 窗开启方向的定义  
THE DEFINITION FOR WINDOW OPENING DIRECTION.  
2.1 从窗页开启面看, 铰链在左侧为左开式(L), 铰链在右侧为右开式(R)。  
VIEW FROM HINGE SIDE, HINGE ON LEFT SIDE CALLED LEFT TYPE, HINGE ON RIGHT SIDE CALLED RIGHT TYPE.



2.2 当视向正对屏蔽窗屏蔽内窗页开启面, 屏蔽窗页铰链在左侧为左内开式(A1)窗, 屏蔽窗页铰链在右侧为右内开式(A2)窗, 见下图。  
FOR INWARD OPENING ELECTROMAGNETIC SHIELDING WINDOW, LOOKING FROM THE OPENING SIDE, THE HINGE ON THE LEFT SIDE CALLED LEFT TYPE (A1), HINGE ON THE RIGHT SIDE CALLED RIGHT TYPE (A2).

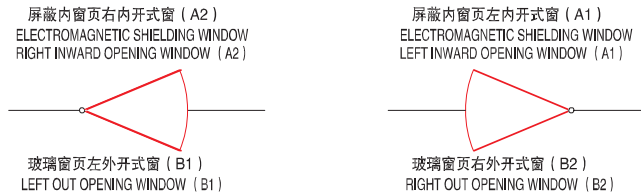

2.3 上铰链式(T), 玻璃窗铰链在上方的开启窗。  
THE WINDOW WITH HINGE ON THE TOP CALLED TOP HINGED WINDOW.  
3. 移窗的定义  
OPENING DIRECTION DEFINITION FOR SLIDING WINDOW.  
观察者站在室内向外窗看, 当窗在关闭状态下转为开启时, 外窗向左移动的为左式(L)移窗, 外窗向右移动的为右式(R)移窗。  
VIEW FROM INDOOR, OUTSIDE WINDOW LEAF OPENS TOWARD LEFT CALLED LEFT TYPE. OUTSIDE WINDOW LEAF OPENS TOWARD RIGHT CALLED RIGHT TYPE.

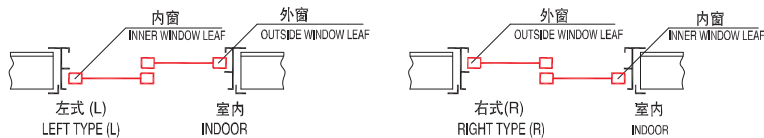

## 船用风雨密单扇钢质门 MARINE WEATHERTIGHT SINGLE-LEAF STEEL DOOR

GB/T 3477-2008

适用于船舶干舷甲板以上的上层建筑及甲板室出入口使用的门, 满足ISO 6042-1998  
USED FOR DOORWAY OF SUPERSTRUCTURE ABOVE FREEBOARD DECK OR DECK HOUSE TO MEET ISO 6042-1998

1. 门的分级及适用部位 CLASS OF DOOR AND USED FOR STATION

级别 CLASS	适用部位 USED FOR STATION
A	干舷甲板上的第一层上层建筑的前端壁(由舰垂线向前(0.1-0.7) L范围) FORWARD BULKHEAD ON THE FIRST DECK ABOVE FREEBOARD [FROM AFT PERPENDICULAR TO (0.1L-0.7L)]
B	干舷甲板上的第二层上层建筑的前端壁(由舰垂线向前(0.1-0.7) L范围)和第一层上层建筑的后端壁及侧壁 FORWARD BULKHEAD ON THE SECOND DECK ABOVE FREEBOARD [FROM AFT PERPENDICULAR TO (0.1L-0.7L)] AND AFT & SIDE BULKHEAD ON THE FIRST DECK
C	干舷甲板上的第三层上层建筑的前端壁(由舰垂线向前(0.2-0.6) L范围)和第二层上层建筑的后端壁及侧壁 FORWARD BULKHEAD ON THE THIRD DECK ABOVE FREEBOARD [FROM AFT PERPENDICULAR TO (0.2L-0.6L)] AND AFT & SIDE BULKHEAD ON THE SECOND DECK
D	干舷甲板上的第四层上层建筑以上的舱壁和第三层上层建筑的后端壁及侧壁 BULKHEAD ON THE FOURTH DECK AND UP ABOVE FREEBOARD, AFT, & SIDE BULKHEAD ON THE THIRD DECK

2. 门的型式及规格 TYPE AND SPECIFICATION OF DOOR

型式 TYPE	名称 NAME	适用尺寸 APPLICABLE DIMENSION
AF	A级方角门 CLASS A RECTANGULAR CORNER DOOR	1200X600, 1400X600, 1400X700, 1400X750, 1400X800, 1400X900 1500X600, 1500X700, 1500X800, 1600X600, 1600X700, 1600X750 1600X800, 1600X900, 1650X650, 1650X700, 1700X600, 1700X700 1700X800
AY	A级圆角门 CLASS A ROUND CORNER DOOR	
BF	B级方角门 CLASS B RECTANGULAR CORNER DOOR	
BY	B级圆角门 CLASS B ROUND CORNER DOOR	
CF	C级方角门 CLASS C RECTANGULAR CORNER DOOR	
CY	C级圆角门 CLASS C ROUND CORNER DOOR	
DF	D级方角门 CLASS D RECTANGULAR CORNER DOOR	1200X600, 1400X600, 1400X700, 1400X750, 1400X800, 1400X900 1500X600, 1500X700, 1500X800, 1600X600, 1600X700, 1600X750 1600X800, 1600X900, 1650X650, 1650X700, 1700X600, 1700X700 1700X800, 1800X600, 1800X750, 1800X900
DY	D级圆角门 CLASS D ROUND CORNER DOOR	

注: 1. 可以根据客户要求装配门钩、门碰、闭门器、C2锁、ISPS装置等。  
2. C级和D级门可按客户要求安装φ250mm的圆窗, 代号为“G”。  
NOTE: 1. HOOK, BUMPER, DOOR CLOSER, C2 LOCK AND ISPS DEVICE COULD BE EQUIPPED ACC. TO CUSTOMER'S REQUIREMENTS.  
2. CLASS C & D DOOR MAY BE EQUIPPED WITH φ250 mm PORT LIGHT, THE CODE IS "G".

3. 门的节点型式 SECTION OF DOOR

门框厚 THICKNESS OF DOOR	挡板尺寸 SIZE OF SEAL RETAINER	门框高度 HEIGHT OF DOOR FRAME	门框材料 MATERIAL OF DOOR FRAME
t	h1xh1	h	
8	50X6	32	L100X63X10割制 CUT FROM L100X63X10
6		34	
4	32X4	36	L100X63X8割制 CUT FROM L100X63X8

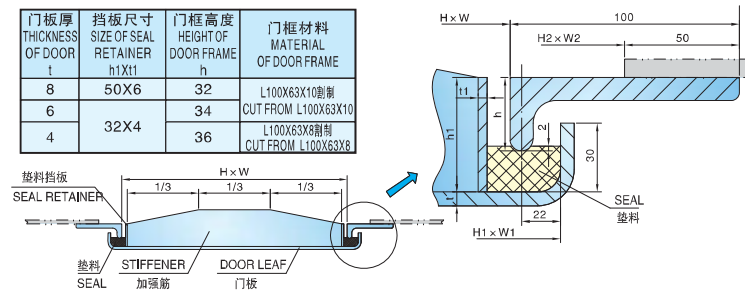



舰船装备 出类拔萃 海联产品 情联四海

### 船用风雨密单扇钢质门 MARINE WEATHERTIGHT SINGLE-LEAF STEEL DOOR

GB/T 3477-2008

4、AF、AY型钢质门 TYPE AF、AY STEEL DOOR

AF型 TYPE AF

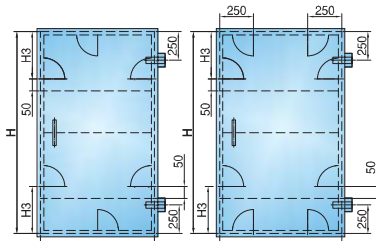

- 1 200X600 1 400X600  
1 400X700 1 400X750  
1 500X600 1 500X700  
1 600X600 1 600X700  
1 600X750 1 650X650  
1 650X700 1 700X600  
1 700X700
- 1 400X800 1 400X900  
1 500X800 1 600X800  
1 600X900 1 700X800

AY型 TYPE AY

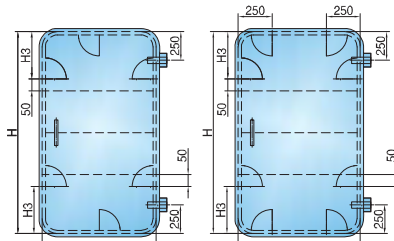

- 1 200X600 1 400X600  
1 400X700 1 400X750  
1 500X600 1 500X700  
1 600X600 1 600X700  
1 600X750 1 650X650  
1 650X700 1 700X600  
1 700X700
- 1 400X800 1 400X900  
1 500X800 1 600X800  
1 600X900 1 700X800

通孔尺寸 SIZE OF DOORWAY HxW	门板尺寸 SIZE OF DOOR H1xW1	顶壁开孔尺寸 SIZE OF B. H. OPENING H2xW2		门板厚度 THICK. OF DOOR LEAF	加强筋 STIFFENER						轧扣数量及安装尺寸 QTY. AND INSTALL. OF DOGS			重量 WEIGHT KG		
		AF	AY		船长 SHIP LENGTH(m)						H3	轧扣数量 QTY.	6mm 8mm			
					≤80	>80	≤80	80-120	120-150	150-210			210-300	重量	重量	
1200X600	1255X655	1300X700	R80	1300X700	R150	6	8	75X6	—	—	—	—	350	6	123.80	—
1400X600	1455X655	1500X700	R80	1500X700	R150	6	8	65X9	65X9	75X9	75X9	380	6	152.33	176.56	
1400X700	1455X755	1500X800	R80	1500X800	R150	6	8	75X9	75X12	75X12	90X12	380	6	158.26	180.00	
1400X750	1455X805	1500X850	R80	1500X850	R150	6	8	75X9	75X12	90X9	90X12	380	6	162.24	192.33	
1400X800	1455X855	1500X900	R80	1500X900	R150	—	8	—	90X12	90X12	90X12	90X12	380	8	—	204.66
1400X900	1455X955	1500X1000	R80	1600X1000	R150	—	8	—	90X9	90X12	100X12	100X12	380	8	—	222.47
1500X600	1555X655	1600X700	R80	1600X700	R150	—	8	—	75X6	90X12	75X12	90X12	410	6	—	164.43
1500X700	1555X755	1600X800	R80	1600X800	R150	—	8	—	75X12	75X9	75X12	90X12	410	6	—	188.62
1500X800	1555X855	1600X900	R80	1600X900	R150	—	8	—	90X12	90X12	90X12	90X12	410	8	—	217.80
1600X600	1655X655	1700X700	R80	1700X700	R150	—	8	—	65X9	75X9	75X12	75X12	410	6	—	188.14
1600X700	1655X755	1700X800	R80	1700X800	R150	—	8	—	75X12	90X12	90X12	90X12	410	6	—	217.14
1600X750	1655X805	1700X850	R80	1700X850	R150	—	8	—	75X12	90X9	90X12	90X12	410	6	—	216.48
1600X800	1655X855	1700X900	R80	1700X900	R150	—	8	—	90X12	100X12	100X12	90X12	410	8	—	219.25
1600X900	1655X955	1700X1000	R80	1700X1000	R150	—	8	—	90X12	100X12	125X9	125X9	410	8	—	242.57
1650X650	1705X705	1750X750	R80	1750X750	R150	—	8	—	75X6	90X9	90X12	90X12	410	6	—	186.59
1650X700	1705X755	1750X800	R80	1750X800	R150	—	8	—	75X12	90X12	90X12	90X12	410	6	—	200.59
1700X600	1755X655	1800X700	R80	1800X700	R150	—	8	—	75X6	90X9	90X12	90X9	410	6	—	179.59
1700X700	1755X755	1800X800	R80	1800X800	R150	—	8	—	75X12	90X12	125X9	125X9	410	6	—	205.25
1700X800	1755X855	1800X900	R80	1800X900	R150	—	8	—	90X12	100X12	125X9	125X9	410	6	—	230.90

标记示例:

通孔尺寸为1600X600门板厚为8mm, 加强筋为(65X9)mm的A级方角风雨密单扇钢质门(右外开式) 风雨密钢质门 AF1600X600-8-65X9-5.1 GB/T 3477-2008.



舰船装备 出类拔萃 海联产品 情联四海

### 船用风雨密单扇钢质门 MARINE WEATHERTIGHT SINGLE-LEAF STEEL DOOR

GB/T 3477-2008

5、BF、BY、CF、CY型钢质门 TYPE BF、BY、CF、CY STEEL DOOR

BF, CF型 TYPE BF, CF

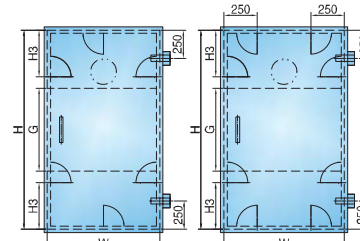

- 1 200X600 1 400X600  
1 400X700 1 400X750  
1 500X600 1 500X700  
1 600X600 1 600X700  
1 600X750 1 650X650  
1 650X700 1 700X600  
1 700X700
- 1 400X800 1 400X900  
1 500X800 1 600X800  
1 600X900 1 700X800

BY, CY型 TYPE BY, CY

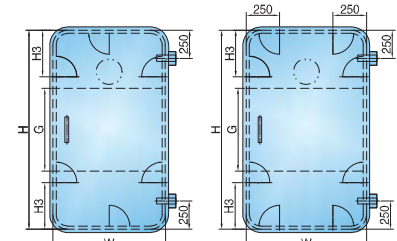

- 1 200X600 1 400X600  
1 400X700 1 400X750  
1 500X600 1 500X700  
1 600X600 1 600X700  
1 600X750 1 650X650  
1 650X700 1 700X600  
1 700X700
- 1 400X800 1 400X900  
1 500X800 1 600X800  
1 600X900 1 700X800

通孔尺寸 SIZE OF DOORWAY HxW	门板尺寸 SIZE OF DOOR H1xW1	围壁开孔尺寸 SIZE OF B. H. OPENING H2xW2		门板厚度 THICK. OF DOOR LEAF	加强筋 STIFFENER						轧扣数量及 安装尺寸 QTY. AND INSTALL. OF DOGS			重量 WEIGHT KG								
		BF, CF	BY, CY		船长 SHIP LENGTH(m)						G	轧扣数量 QTY.	4 6 8									
					≤80	>80	≤80	80-150	150-210	210-300			≤80	80-140	140-300	重量	重量					
1200X600	1255X655	1300X700	R80	1300X700	R150	6	4	—	50X5	—	—	—	50X5	—	—	400	6	350	85.93	122.82	—	
1400X600	1455X655	1500X700	R80	1500X700	R150	6	4	6	50X5	65X6	65X6	65X9	50X5	65X6	65X6	460	6	350	97.25	141.15	170.78	
1400X700	1455X755	1500X800	R80	1500X800	R150	6	4	6	50X5	65X9	75X9	75X9	50X5	65X6	65X6	460	6	350	116.26	144.15	172.30	
1400X750	1455X805	1500X850	R80	1500X850	R150	6	4	6	50X5	65X9	75X9	75X9	50X5	65X6	65X6	460	6	350	122.54	152.01	184.10	
1400X800	1455X855	1500X900	R80	1500X900	R150	—	8	—	6	—	75X9	75X9	75X12	—	65X6	65X6	460	8	350	—	182.48	195.30
1400X900	1455X955	1500X1000	R80	1600X1000	R150	—	8	—	6	—	75X9	75X12	75X12	—	65X6	65X9	460	8	350	—	198.12	210.81
1500X600	1555X655	1600X700	R80	1600X700	R150	—	8	—	6	—	65X6	65X9	75X9	—	65X6	65X6	540	6	350	—	133.86	160.50
1500X700	1555X755	1600X800	R80	1600X800	R150	—	8	—	6	—	65X9	75X9	75X9	—	65X6	65X6	540	6	350	—	154.83	184.10
1500X800	1555X855	1600X900	R80	1600X900	R150	—	8	—	6	—	75X9	75X12	75X12	—	65X6	65X6	540	8	350	—	173.98	207.70
1600X600	1655X655	1700X700	R80	1700X700	R150	—	8	—	6	—	65X6	65X9	65X9	—	65X6	65X6	540	6	410	—	147.83	175.86
1600X700	1655X755	1700X800	R80	1700X800	R150	—	8	—	6	—	65X9	75X9	75X12	—	65X6	65X6	540	6	410	—	141.95	190.03
1600X750	1655X805	1700X850	R80	1700X850	R150	—	8	—	6	—	65X9	75X9	75X12	—	65X6	65X6	540	6	410	—	151.11	201.48
1600X800	1655X855	1700X900	R80	1700X900	R150	—	8	—	6	—	75X9	75X12	90X12	—	65X6	65X6	540	8	410	—	182.58	215.22
1600X900	1655X955	1700X1000	R80	1700X1000	R150	—	8	—	6	—	75X9	75X12	90X12	—	65X6	65X9	540	8	410	—	174.93	233.32
1650X650	1705X705	1750X750	R80	1750X750	R150	—	8	—	6	—	65X9	65X9	75X9	—	65X6	65X6	540	6	410	—	184.37	195.40
1650X700	1705X755	1750X800	R80	1750X800	R150	—	8	—	6	—	75X9	75X9	75X12	—	65X6	65X6	540	6	410	—	157.54	210.06
1700X600	1755X655	1800X700	R80	1800X700	R150	—	8	—	6	—	65X9	75X9	75X12	—	65X6	65X6	540	6	410	—	140.89	188.08
1700X700	1755X755	1800X800	R80	1800X800	R150	—	8	—	6	—	75X9	75X12	90X12	—	65X6	65X9	540	6	410	—	161.21	214.35
1700X800	1755X855	1800X900	R80	1800X900	R150	—	8	—	6	—	75X9	75X12	90X12	—	65X6	65X9	540	8	410	—	181.38	241.82

标记示例:

通孔尺寸为1600X600门板厚为8mm, 加强筋为(65X9)mm的B级圆角风雨密单扇钢质门(右外开式) 风雨密钢质门 BY1600X600-8-65X9-5.1 GB/T 3477-2008.



舰船装备 出类拔萃 海联产品 情联四海

## 船用风雨密单扇钢质门 MARINE WEATHERTIGHT SINGLE-LEAF STEEL DOOR

GB/T 3477-2008

6、DF、DY型钢质门 TYPE DF, DY STEEL DOOR

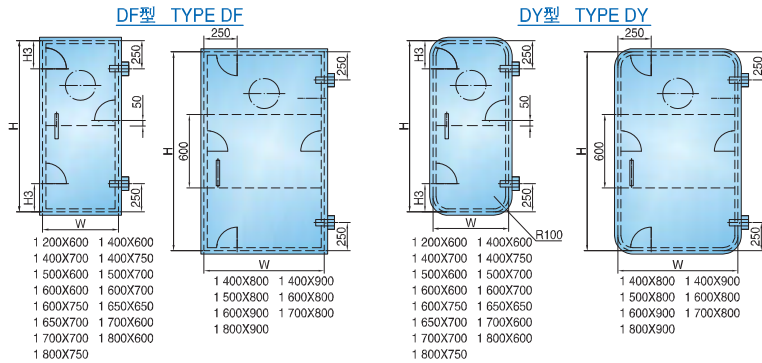

通孔尺寸 SIZE OF DOORWAY HXW	门板尺寸 SIZE OF DOOR HXW1	围壁开孔尺寸 SIZE OF B. H.OPENING H2XW2		门板厚度 THK OF DOOR LEAF	加强筋 THK OF STIFFENER 宽X厚	门框数量及安装尺寸 QTY. AND INSTALL. OF DOGS			重量 WEIGHT KG	
		DF	DY			乳扣数 QTY.	H3	4	6	
1200X600	1255X655	1300X700 R80	1300X700 R150	4	50X5	3	180	75.01	—	—
1400X600	1455X655	1500X700 R80	1500X700 R150	4	50X5	3	180	97.25	—	—
1400X700	1455X755	1500X800 R80	1500X800 R150	4	50X5	3	180	99.20	—	—
1400X750	1455X805	1500X850 R80	1500X850 R150	4	50X5	3	180	102.54	—	—
1400X800	1455X855	1500X900 R80	1500X900 R150	4	50X5	4	—	107.80	—	—
1400X900	1455X955	1500X1000 R80	1500X1000 R150	4	50X5	4	—	134.81	—	—
1500X600	1555X655	1600X700 R80	1600X700 R150	6	65X6	3	180	—	131.63	—
1500X700	1555X755	1600X800 R80	1600X800 R150	6	65X6	3	180	—	133.20	—
1500X800	1555X855	1600X900 R80	1600X900 R150	6	65X6	3	180	—	135.45	—
1600X600	1655X655	1700X700 R80	1700X700 R150	6	65X6	3	180	—	139.37	—
1600X700	1655X755	1700X800 R80	1700X800 R150	6	65X6	3	180	—	147.33	—
1600X750	1655X805	1700X850 R80	1700X850 R150	6	65X6	3	180	—	156.83	—
1600X800	1655X855	1700X900 R80	1700X900 R150	6	65X6	4	—	—	162.54	—
1600X900	1655X955	1700X1000 R80	1700X1000 R150	6	65X6	4	—	—	178.57	—
1650X650	1705X705	1750X750 R80	1750X750 R150	6	65X6	3	180	—	137.36	—
1650X700	1705X755	1750X800 R80	1750X800 R150	6	65X6	3	180	—	148.80	—
1700X600	1755X655	1800X700 R80	1800X700 R150	6	65X6	3	180	—	132.78	—
1700X700	1755X755	1800X800 R80	1800X800 R150	6	65X6	3	180	—	151.10	—
1700X800	1755X855	1800X900 R80	1800X900 R150	6	65X6	4	—	—	169.41	—
1800X600	1855X655	1900X700 R80	1900X700 R150	6	65X6	3	180	—	136.91	—
1800X750	1855X805	1900X850 R80	1900X850 R150	6	65X6	3	180	—	156.83	—
1800X900	1855X955	1900X1000 R80	1900X1000 R150	6	65X6	4	—	—	178.57	—

标记示例:

通孔尺寸为1400X750门板厚为4mm, 加强筋为(50X5)mm的D级方角风雨密单扇钢质门(右外开式)  
风雨密钢质门 DF1400X750-4-50X5-5.1 GB/T 3477-2008.



舰船装备 出类拔萃 海联产品 情联四海

## 钢质快开闭风雨密(水密)门 STEEL QUICK ACTION WEATHERTIGHT DOOR/WATERTIGHT DOOR

262WHL003A-00  
262WHL003M-00

这两种门既可用作风雨密门也可用作水密门, 如用作水密门时, 水压不能超过0.07MPa  
THESE TWO TYPE DOORS COULD BE USED AS BOTH WEATHERTIGHT AND WATERTIGHT DOOR WHILE  
USED AS WATERTIGHT DOOR, THE PRESSURE NO MORE THAN 0.07MPa

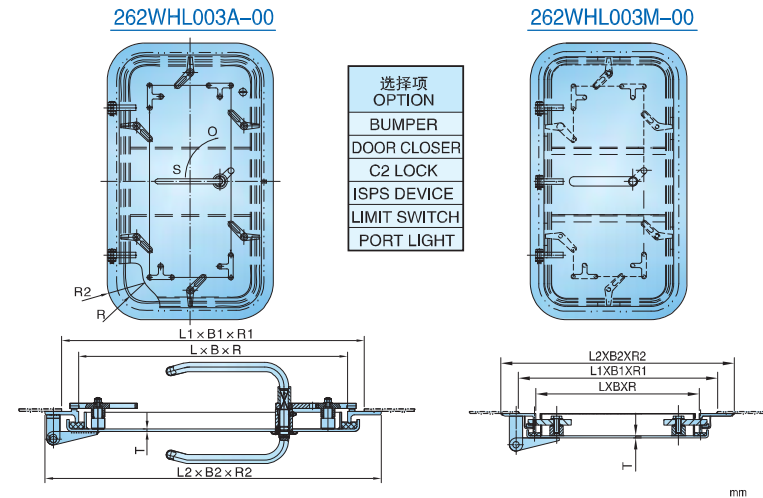

通孔尺寸 SIZE OF DOORWAY LXBXR	围壁开孔尺寸 SIZE OF B.H.OPENING L1XB1XR1	外形尺寸 SIZE OF OUTLINE L2XB2XR2	门框厚度 THICKNESS T	重量 WEIGHT kg	
				262WHL003A-00	262WHL003M-00
1400X600XR100	1500X700XR150	1600X800XR200	6	120	129
			8	138	147
1400X900XR100	1500X1000XR150	1600X1100XR200	6	145	160
			8	175	185
1600X600XR100	1700X700XR150	1800X800XR200	6	126	137
			8	144	155
1600X750XR100	1700X850XR150	1800X950XR200	6	147	161
			8	172	186
1600X900XR100	1700X1000XR150	1800X1100XR200	6	163	178
			8	191	206

标记示例:

通孔尺寸为1600X600门板厚为8mm, 钢质风雨密门(左外开式), 262WHL003A-00

钢质快开闭风雨密门1600X600-8-6.1 262WHL003A-00

通孔尺寸为1600X750门板厚为8mm, 钢质快开闭水密(左外开式), 262WHL003M-00

钢质快开闭水密门 1600X750-8-6.1 262WHL003M-00



舰船装备 出类拔萃 海联产品 情联四海

**快开闭风雨密钢质门(埋入式)** **262WHL002-00**  
**QUICK OPEN&CLOSE WEATHERTIGHT STEEL DOOR (FLUSH TYPE)**

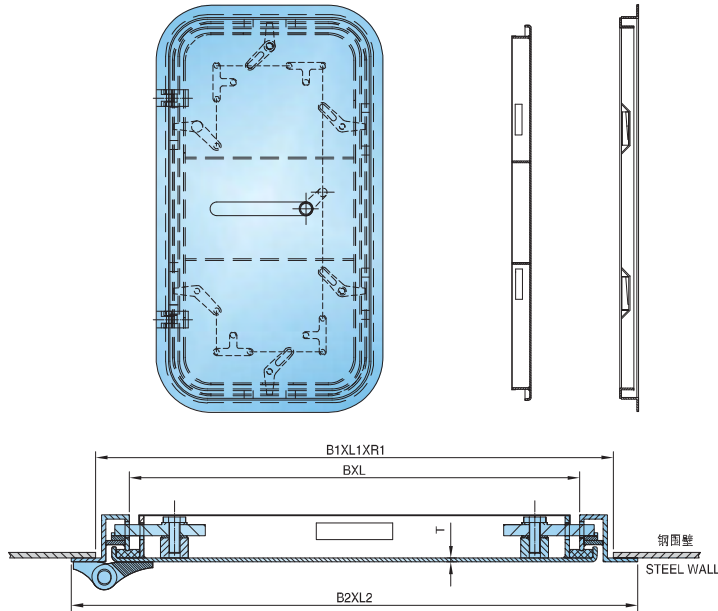

通孔尺寸 SIZE OF DOORWAY BXL	围壁开孔尺寸 SIZE OF B.H. OPENING B1XL1XR1	门框尺寸 FRAME SIZE B2XL2	重量 WEIGHT KG	
			门板厚度Tmm THICK. OF DOOR LEAF	
			6	8
600X1650	720X1770X160	786X1836	166	191
650X1650	770X1770X160	836X1836	177	205
700X1650	820X1770X160	886X1836	188	219

选择项 OPTION
BUMPER
DOOR CLOSER
C2 LOCK
ISPS DEVICE
LIMIT SWITCH
PORT LIGHT

标记示例:

通孔尺寸为650X1650门板厚为6mm, 快开闭风雨密钢质门(埋入式)(左外开式)  
 快开闭风雨密钢质门(埋入式) 650X1650-6-6.1 262WHL-002-00



舰船装备 出类拔萃 海联产品 情联四海

**快开闭风雨密钢质门(圆盘式)** **262WHL097-00**  
**QUICK OPEN&CLOSE WEATHERTIGHT STEEL DOOR(HAND WHEEL TYPE)**

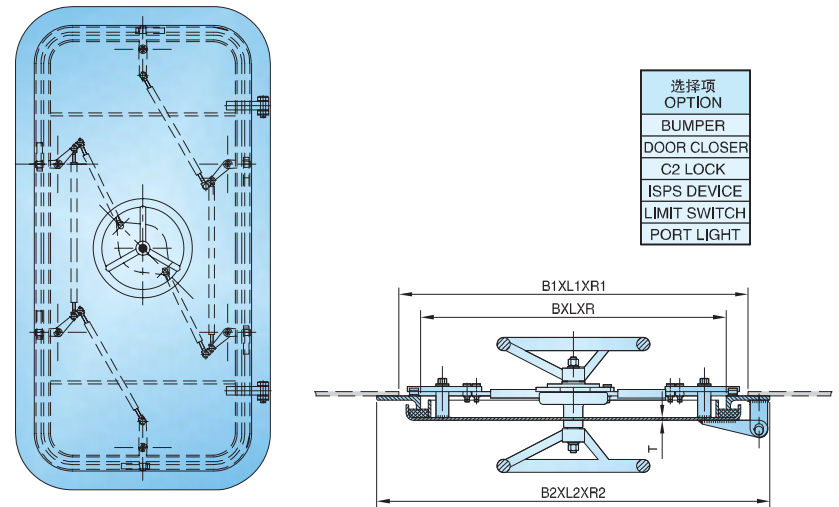

选择项 OPTION
BUMPER
DOOR CLOSER
C2 LOCK
ISPS DEVICE
LIMIT SWITCH
PORT LIGHT

通孔尺寸 SIZE OF DOORWAY BXLXR	围壁开孔尺寸 SIZE OF B.H. OPENING B1XL1XR1	外形尺寸 SIZE OF OUTLINE B2XL2XR2	门板厚度 THICKNESS T	重量 WEIGHT kg
600X1500X100	700x1600x150	800X1700X200	6 8	145 166
600X1600X100	700x1700x150	800X1800X200	6 8	154 176
700X1500X100	800x1600x150	900X1700X200	6 8	167 191
700X1600X100	800x1700x150	900X1800X200	6 8	174 199
700X1700X100	800x1800x150	900X1900X200	6 8	183 210
800X1500X100	900x1600x150	1000X1700X200	8	208
800X1600X100	900x1700x150	1000X1800X200	8	223
800X1700X100	900x1800x150	1000X1900X200	8	249

标记示例:

通孔尺寸为600X1600门板厚为8mm, 快开闭风雨密钢质门(圆盘式)(右外开式)  
 快开闭风雨密钢质门(圆盘式) 600X1600-8-5.1 262WHL-097-00





舰船装备 出类拔萃 海联产品 情联四海

**钢质双扇快开闭风雨密门** 262WHL003MS-00  
**STEEL DOUBLE-LEAF QUICK ACTION WEATHERTIGHT DOOR**

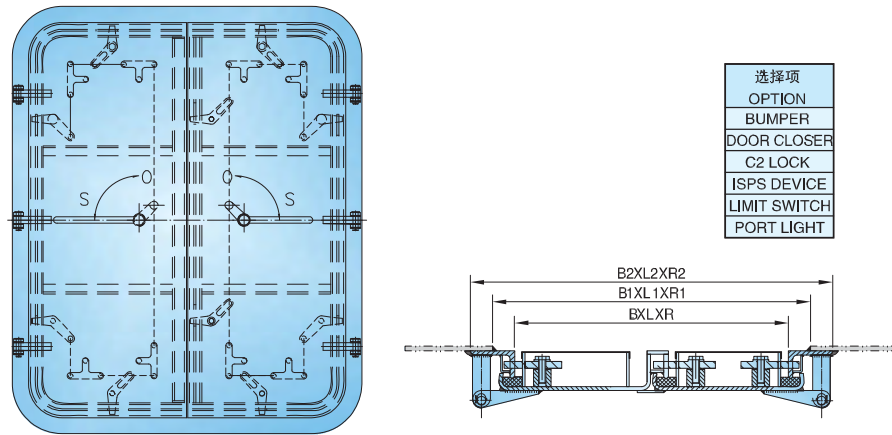

通孔尺寸 SIZE OF DOORWAY BXL	围壁开孔尺寸 SIZE OF B.H.OPENING B1XL1XR1	外型尺寸 SIZE OF OUT LINE B2XL2	门板厚度 THICKNESS T	重量 WEIGHT KG
1000X1600XR100	1100X1700XR150	1200X1800XR200	6	203
			8	241
1200X1600XR100	1300X1700XR150	1400X1800XR200	6	230
			8	265
1000X1700XR100	1100X1800XR150	1200X1900XR200	6	216
			8	247
1200X1700XR100	1300X1800XR150	1400X1900XR200	6	241
			8	278
1200X1800XR100	1300X1900XR150	1400X2000XR200	6	250
			8	289

标记示例:

通孔尺寸为1000X1600门板厚为8mm, 钢质双扇快开闭风雨密门  
 钢质双扇快开闭风雨密门 1000X1600-8-5.1&6.1 262WHL003MS-00



舰船装备 出类拔萃 海联产品 情联四海

**钢质耐压水密门** 262WHL095-00  
**STEEL PRESSURE RESISTANT WATERTIGHT DOOR**

本门适用压力为不大于0.15MPa。  
 THE APPLICABLE WATER PRESSURE FOR THE DOOR IS NO MORE THAN 0.15MPa.

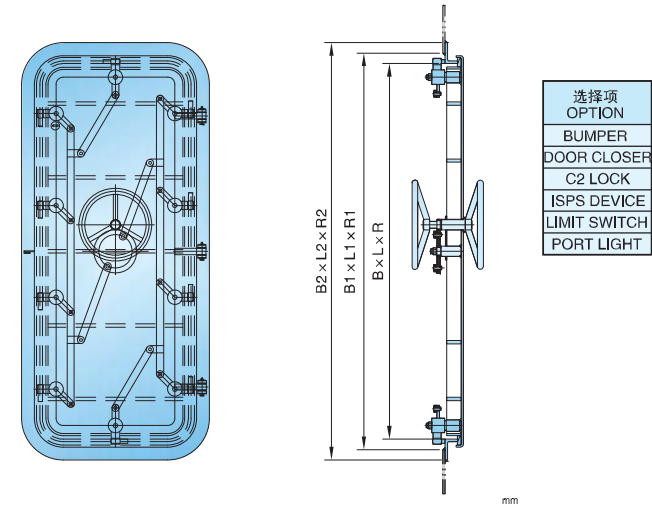

通孔尺寸 SIZE OF DOORWAY BXLXR	围壁开孔尺寸 SIZE OF B.H.OPENING B1XL1XR1	外型尺寸 SIZE OF OUT LINE B2XL2XR2	门板厚度 THICKNESS T	重量 WEIGHT KG
600X1500X100	700X1600X150	800X1700X200	8	206
600X1600X100	700X1700X150	800X1800X200		212
700X1500X100	800X1600X150	900X1700X200		227
700X1600X100	800X1700X150	900X1800X200		239
700X1700X100	800X1800X150	900X1900X200		250
800X1500X100	900X1600X150	1000X1700X200		248
800X1600X100	900X1700X150	1000X1800X200		263
800X1700X100	900X1800X150	1000X1900X200		289

标记示例:

通孔尺寸为600X1500, 门板厚为8mm的钢质耐压水密门, (右外开式)  
 钢质耐压水密门 600X1500-8-5.1 262WHL095-00



舰船装备 出类拔萃 海联产品 情联四海

## 钢质耐高压水密门 STEEL HIGH PRESSURE RESISTANT WATERTIGHT DOOR

262WHL095C-00

本门适用压力为不大于0.5MPa。  
THE APPLICABLE WATER PRESSURE FOR THE DOOR IS NO MORE THAN 0.5MPa.

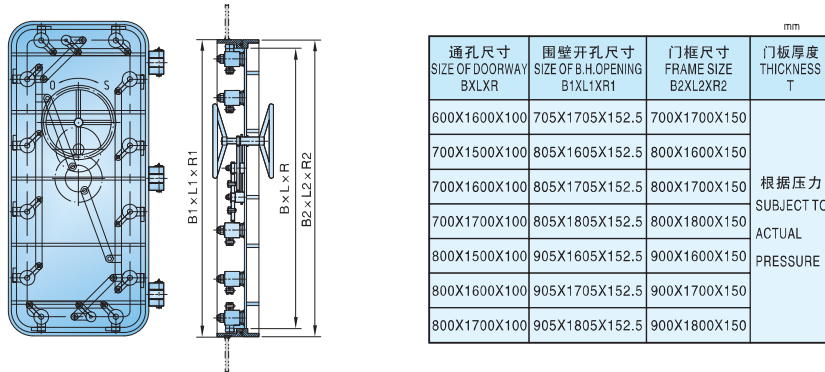

标记示例:

通孔尺寸为600X1500mm, 门板厚为8mm的钢质耐高压水密门, (右外开式)

钢质耐高压水密门 600X1500-8-5.1 262WHL095C-00

## A60 钢质耐压水密门 A60 STEEL PRESSURE RESISTANT WATERTIGHT DOOR

262WHL095F-00

本门适用压力为不大于 0.5MPa,  
最大尺寸为1200mmX2300mm (宽X高)。

THE APPLICABLE WATER PRESSURE FOR THE DOOR  
IS NO MORE THAN 0.5 MPa, THE MAX. SIZE IS  
1200X2300mm (width X height).

标记示例:

通孔尺寸为600X1500mm, 门板厚为8mm的A60钢质耐压  
水密门 (右外开式)

A60钢质耐压水密门 600X1500-8-5.1 262WHL095F-00

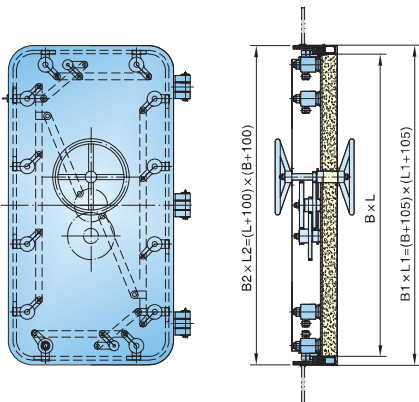

舰船装备 出类拔萃 海联产品 情联四海

## 船用风雨密单扇铝质门 MARINE WEATHERTIGHT SINGLE-LEAF ALUMINIUM DOOR

CB/T 454-1997

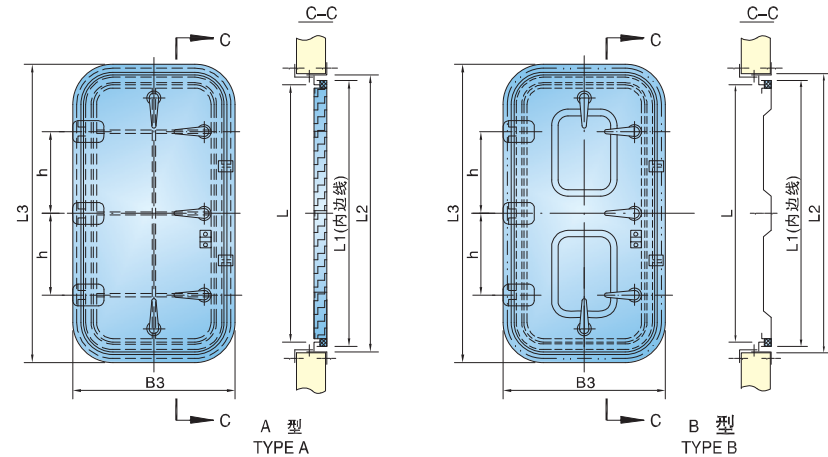

类型 TYPE	名称 NAME	通孔尺寸 SIZE OF DOORWAY BXL			选择项 OPTION
A	构架式船用风雨密单扇铝质门 FRAME TYPE WEATHERTIGHT SINGLE-LEAF ALUMINIUM DOOR	500X1000 600X1200	500X1200 600X1400	500X1400 650X1600	HOOK BUMPER, PORTLIGHT
B	模压式船用风雨密单扇铝质门 MOULD TYPE WEATHERTIGHT SINGLE-LEAF ALUMINIUM DOOR	500X1000	500X1200	600X1200	

通孔尺寸 SIZE OF DOORWAY BXLXR	门板理论尺寸(内边线) SIZE OF DOOR B1XL1XR1	围壁开孔尺寸 SIZE OF B.H.OPENING B2XL2XR2	门框外形尺寸 SIZE OF OUTLINE B3XL3XR3	铰链把手位置尺寸 h	把手数量 OUT.OF CLIPS	重量 WEIGHT KG	
500X1000X100	540X1040X120	580X1080X140	654X1154X177	300	4	23	21
500X1200X100	540X1240X120	580X1280X140	654X1354X177	400	5	27	25
500X1400X100	540X1440X120	580X1480X140	654X1554X177	500	5	30	27
600X1200X100	640X1240X120	680X1280X140	754X1354X177	400	5	33	30
600X1400X100	640X1440X120	680X1480X140	754X1554X177	500	5	36	33
650X1600X100	690X1640X120	730X1680X140	804X1754X177	600	5	39.5	36

标记示例:

通孔尺寸为600X1400mm的A型左外开船用风雨密单扇铝质门

船用风雨密单扇铝质门 A600X1400-6.1 CB/T 454-1997



舰船装备 出类拔萃 海联产品 情联四海

**快开闭风雨密铝质门** 262WHL093D-00  
**QUICK OPEN & CLOSE WEATHERTIGHT ALUMINIUM DOOR**

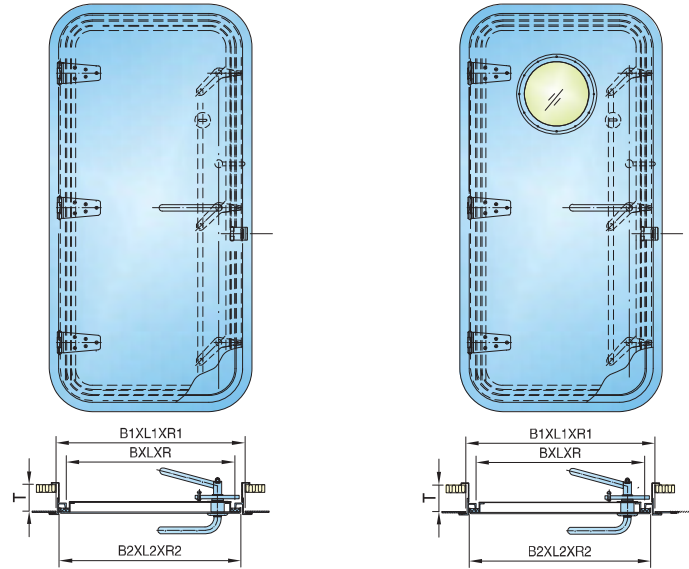

A型 - 快开闭风雨密铝质门      B型 - 快开闭风雨密铝质门  
 TYPE A QUICK OPEN & CLOSE WEATHERTIGHT ALUMINIUM DOOR    TYPE B QUICK OPEN & CLOSE WEATHERTIGHT ALUMINIUM DOOR

类型 TYPE	通孔尺寸 SIZE OF DOORWAY BxLxR	围壁开孔尺寸 SIZE OF B.H.OPENING B1xL1xR1	门板尺寸 SIZE OF DOOR B2xL2xR2	门板厚度 THICKNESS	重量 WEIGHT KG	选择项 OPTION
A	600X1200X100	680X1280X140	648X1248X124	4	32	门钩 门碰 BUMPER
	650X1400X100	730X1480X140	698X1448X124		35	
	650X1600X100	730X1680X140	698X1648X124		38	
	700X1600X100	780X1680X140	748X1648X124		39	
B	600X1200X100	680X1280X140	648X1248X124		34	
	650X1400X100	730X1480X140	698X1448X124		37	
	650X1600X100	730X1680X140	698X1648X124		40	
	700X1600X100	780X1680X140	748X1648X124		41	

标记示例:

通孔尺寸为650X1600的A型快开闭风雨密铝质门(左外开式)  
 快开闭风雨密铝质门 A650X1600-6.1 262WHL093D-00



舰船装备 出类拔萃 海联产品 情联四海

**A60快开闭风雨密钢质门(单, 双)** 262WHL003FM-00  
**A60 QUICK OPEN & CLOSE WEATHERTIGHT STEEL DOOR(SINGLE,DOUBLE)** 262WHL601-00

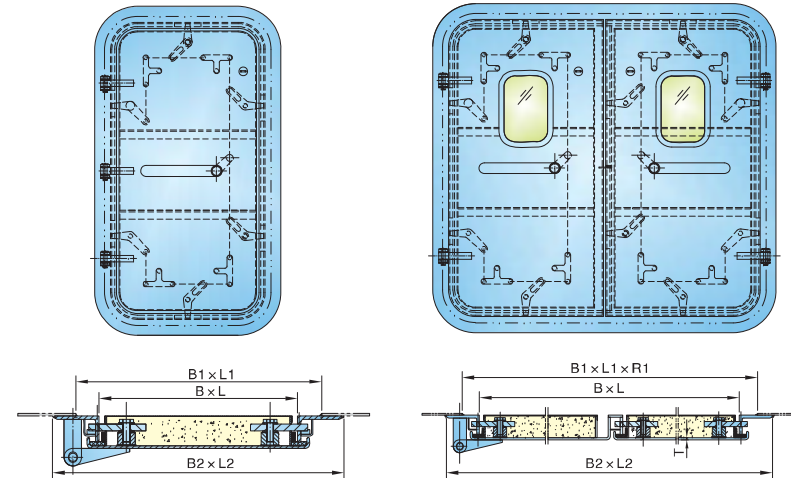

A60快开闭风雨密钢质门(单)      A60快开闭风雨密钢质门(双)  
 A60 QUICK OPEN & CLOSE WEATHERTIGHT STEEL DOOR ( SINGLE )    A60 QUICK OPEN & CLOSE WEATHERTIGHT STEEL DOOR ( DOUBLE )

262WHL003FM-00

262WHL601-00

类型 TYPE	通孔尺寸 SIZE OF DOORWAY BxL	围壁开孔尺寸 SIZE OF B.H.OPENING B1xL1xR1	门框尺寸 FRAME SIZE B2xL2	重量 WEIGHT KG	选择项 OPTION
单扇 SINGLE LEAF 262WHL003FM-00	600X1650	700X1750X150	800X1850	200	门碰 闭门器 DOOR CLOSER C2锁 C2 LOCK ISPS装置 ISPS DEVICE 行程开关 LIMIT SWITCH 方窗 PORT LIGHT
	700X1650	800X1750X150	900X1850	210	
	800X1800	900X1900X150	1000X2000	248	
	1200X2300	1300X2400X150	1400X2500	404	
双扇 DOUBLE-LEAF 262WHL601-00	900X1650	1000X1750X150	1100X1850	300	
	1000X1650	1100X1750X150	1200X1850	340	
	1200X1650	1300X1750X150	1400X1850	357	
	2400X2500	2500X2600X150	2600X2700	825	

注:重量是按T=8mm计算的。

NOTE: THE WEIGHT IS CALCULATED BASED ON THAT T=8mm.

标记示例:

通孔尺寸为600X1650门板厚度为8mm的单扇A60快开闭风雨密钢质门(左外开式)  
 A60快开闭风雨密钢质门(单) 600X1650-8-6.1 262WHL003FM-00

通孔尺寸为1200X1650门板厚度为8mm的双扇A60快开闭风雨密钢质门  
 A60快开闭风雨密钢质门(双) 1200X1650-8-5.1 & 6.1 262WHL601-00



舰船装备 出类拔萃 海联产品 情联四海

### A60快开闭风雨密钢质门 A60 QUICK OPEN & CLOSE WEATHERTIGHT STEEL DOOR

262WHL041-00

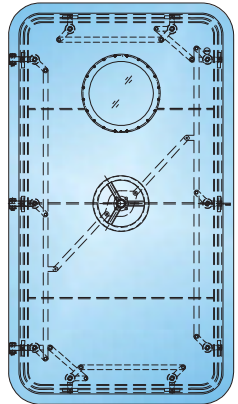

选择项 OPTION
BUMPER
DOOR CLOSER
C2 LOCK
ISPS DEVICE
LIMIT SWITCH
PORT LIGHT

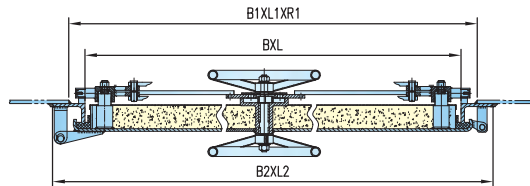

通孔尺寸 SIZE OF DOORWAY BxL	围壁开孔尺寸 SIZE OF B.H.OPENING B1xL1xR1	门框尺寸 FRAME SIZE B2xL2	重量 WEIGHT KG
600X1650	700X1750X150	800X1850	220
700X1650	800X1750X150	900X1850	230
800X1800	900X1900X150	1000X2000	268
1200X2300	1300X2400X150	1400X2500	424

注：重量是按T=8mm计算的。

NOTE: THE WEIGHT IS CALCULATED BASED ON THAT T=8mm.

标记示例：

通孔尺寸为600X1650门板厚度为8mm的单扇A60快开闭风雨密钢质门(左外开式)  
A60快开闭风雨密钢质门 600X1650-8-6.1 262WHL041-00



舰船装备 出类拔萃 海联产品 情联四海

### A0快开闭风雨密钢质门(带窗) A0 QUICK OPEN & CLOSE WEATHERTIGHT STEEL DOOR(WITH WINDOW)

262WHL040-00

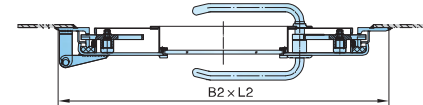
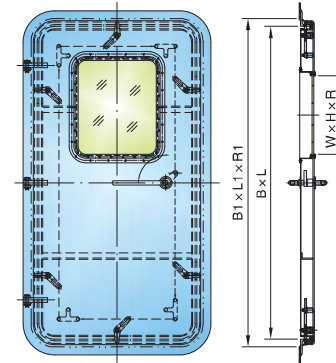

通孔尺寸 SIZE OF DOORWAY BxL	围壁开孔尺寸 SIZE OF B.H.OPENING B1xL1xR1	门框尺寸 FRAME SIZE B2xL2	窗最大透光尺寸 MAX.CLEAR SIZE OF WINDOW WxH	重量 WEIGHT KG t=8mm
700X1600	800X1700X150	900X1800	200X400	184
700X1700	800X1800X150	900X1900	200X450	188
800X1600	900X1700X150	1000X1800	300X400	194
800X1700	900X1800X150	1000X1900	300X450	198
900X1700	1000X1800X150	1100X1900	400X450	208
900X1800	1000X1900X150	1100X2000	400X500	219
1000X2000	1100X2100X150	1200X2200	500X600	243

注：可以根据客户要求装配门碰、闭门器、C2锁、ISPS装置、方窗等。  
NOTE: BUMPER, DOOR CLOSER, C2 LOCK, ISPS DEVICE AND PORTLIGHT MAY BE EQUIPPED ACC. TO CUSTOMER'S REQUIREMENTS.

标记示例：

通孔尺寸为700X1650门板厚度为8mm的A0快开闭风雨密钢质门(带窗) (左外开式)  
A0快开闭风雨密钢质门(带窗) 700X1650-8-6.1 262WHL040-00

### H120防火快开闭风雨密门 H120 FIREPROOF QUICK OPEN & CLOSE WEATHERTIGHT DOOR

262WHL006FM-00

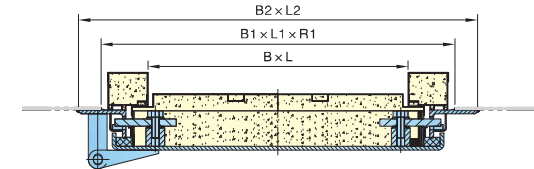
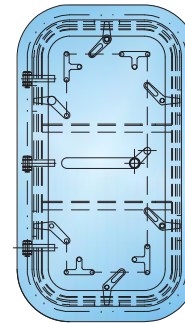

通孔尺寸 SIZE OF DOORWAY BxL	围壁开孔尺寸 SIZE OF B.H.OPENING B1xL1xR1	外形尺寸 SIZE OF OUTLINE B2xL2	门板厚度 THICKNESS T	重量 WEIGHT KG
700X1500	900X1700X200	996X1796	8	235
700X1600	900X1800X200	996X1896	8	240
800X1500	1000X1700X200	1096X1796	8	245
800X1600	1000X1800X200	1096X1896	8	255
900X1900	1100X2100X200	1196X2196	8	285

注：可以根据客户要求装配门碰、闭门器、C2锁、ISPS装置等。  
NOTE: BUMPER, DOOR CLOSER, C2 LOCK AND ISPS DEVICE MAY BE EQUIPPED ACC. TO CUSTOMER'S REQUIREMENTS.

标记示例：

通孔尺寸为700X1500门板厚度为8mm的单扇H120防火快开闭风雨密门(左外开式)  
H120防火快开闭风雨密门 700X1500-8-6.1 262WHL006FM-00



舰船装备 出类拔萃 海联产品 情联四海

## A60级单扇钢质防火水密门(带小门) A60 STEEL SINGLE-LEAF WATERTIGHT DOOR (WITH SMALL DOOR)

262WHL603-00

本门主要用于海工平台、化学品船等船舶及海上建筑物的防火等级为A60级，需要吊装大型设备的通道及场所，平时可通过小门通行，吊运设备时可打开大门。

THE DOOR IS MAINLY USED AT SUCH PASSAGE WAYS AND PLACES, WHERE BIG TYPE EQUIPMENT SHOULD BE LIFTED AND MOVED, AND NORMALLY THE SMALL DOOR IS USED AS ACCESS DOOR AND SOMETIME THE BIG DOOR COULD BE OPENED FOR LIFTING BIG TYPE EQUIPMENT.

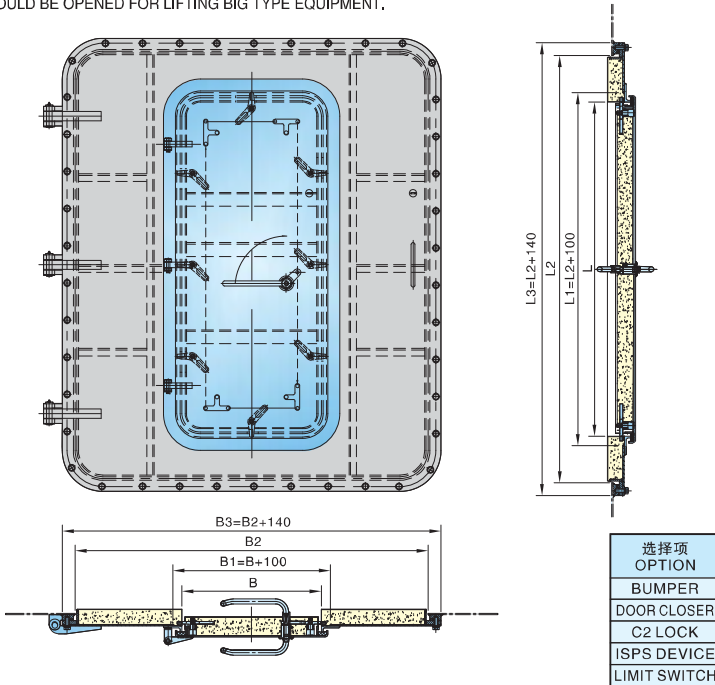

选择项 OPTION
BUMPER
DOOR CLOSER
C2 LOCK
ISPS DEVICE
LIMIT SWITCH

LXB 为小门通孔尺寸，最大尺寸为2000X1100mm LXB IS DOORWAY SIZE OF SMALL DOOR, 2000X1100 mm MAX.  
L1XB1 为小门开孔尺寸 L1XB1 IS CUT SIZE FOR SMALL DOOR  
L2XB2 为大门通孔尺寸，最大尺寸为2300X2100mm L2XB2 IS DOORWAY SIZE OF BIG DOOR, 2300X2100mm MAX.  
L3XB3 为大门外形尺寸 L3XB3 IS OUTLINE SIZE OF BIG DOOR

标记示例:

大门通孔尺寸为2300X1900mm, 门板厚度为10mm, 开向为左开,

小门通孔尺寸为1800X750, 门板厚度为8mm, 开向为左开的A60水密门

A60级单扇钢质防火水密门(带小门) 2300X1900-10-6.1/1800X750-8-6.1 262WHL603-00



舰船装备 出类拔萃 海联产品 情联四海

## 气密门 GASTIGHT DOOR

参照 CB/T 3722-2011

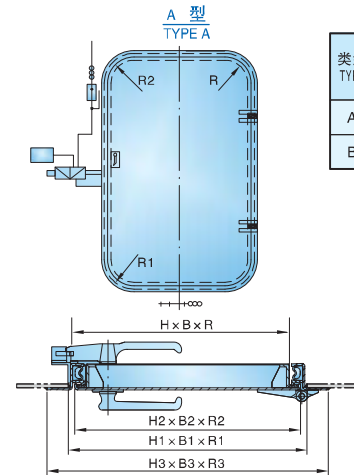

类型 TYPE	名称 DESCRIPTION	开启方向 OPENING DIRECTION	门板材料 MATERIAL OF DOOR	气密性能 GASTIGHT PERFORMANCE (压力差维持值) (PRESSURE DIFFERENCE)
A	铰链式充气密封条密封气密门 HINGED GASTIGHT DOOR WITH INFLATABLE GASKET SEALING	左开 L	不锈钢 N	500pa
B	滑移式机械压紧密封气密门 SLIDING GASTIGHT DOOR WITH MECHANICAL TIGHTENING SEALING	右开 R	铝合金 L	0

通孔尺寸 SIZE OF DOORWAY HXBYR	围壁开孔尺寸 SIZE OF B.H. OPENING H1XB1XR1	门扇外形尺寸 SIZE OF DOOR LEAF H2XB2XR2	门扇外形尺寸 SIZE OF DOOR FRAME H3XB3XR3	重量 WEIGHT kg	
				不锈钢 N	铝合金 L
1600X600 R100	1685X685 R142	1650X650 R125	1800X800 R200	64	44
1650X650 R100	1735X735 R142	1700X700 R125	1850X850 R200	70	48
1700X700 R100	1785X785 R142	1750X750 R125	1900X900 R200	78	52
1750X700 R100	1835X785 R142	1800X750 R125	1950X900 R200	80	54
1700X750 R100	1785X835 R142	1750X800 R125	1900X950 R200	83	56
1750X750 R100	1835X835 R142	1800X800 R125	1950X950 R200	85	59
1800X750 R100	1885X835 R142	1850X800 R125	2000X950 R200	87	62
1800X800 R100	1885X885 R142	1850X850 R125	2000X1000 R200	92	66

B 型  
TYPE B

通孔尺寸 SIZE OF DOORWAY HXBY	围壁开孔尺寸 SIZE OF B.H. OPENING H1XB1	门扇外形尺寸 SIZE OF DOOR LEAF H2XB2	滑轨长 SLIDE WAY B3	重量 WEIGHT kg	
				不锈钢 N	铝合金 L
1700X750	1785X835	1850X830	1950	178	125
1700X900	1785X985	1850X980	2100	191	133
1800X750	1885X835	1950X830	1950	182	128
1800X900	1885X985	1950X980	2100	195	136
1800X1000	1885X1085	1950X1080	2200	204	142

注: 在D=200mm时, 重量计算结果。  
THE WEIGHT IS CALCULATED AT D=200mm.

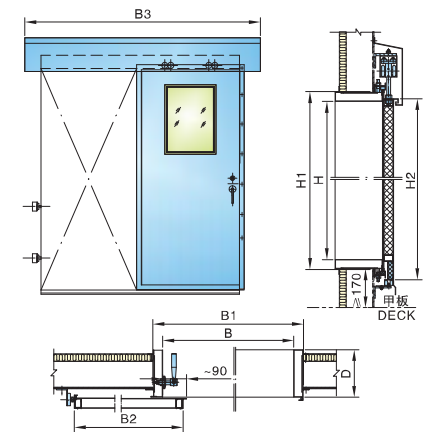

标记示例:

通孔尺寸为1700X750mm A型铰链式充气密封条密封, 右开铝合金气密门

气密门 AR1700X750L CB/T 3722-2011

通孔尺寸为1700X750mm 门框深度为100mm B型滑移式机械压紧密封气密门, 左移开不锈钢

气密门 BL1700X750X100N CB/T 3722-2011



舰船装备 出类拔萃 海联产品 情联四海

**(舱室A型)A60风雨密气密门(单扇, 双扇)**  
**(TYPE A FOR CABIN)A60 WEATHERTIGHT AND GASTIGHT DOOR (SINGLE-LEAF,DOUBLE-LEAF)**

262WHL005M-00  
 262WHL005MS-00

单扇 SINGLE-LEAF  
 262WHL005M-00

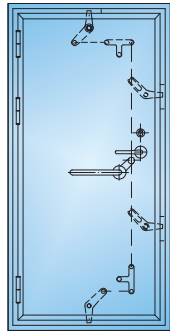

双扇 DOUBLE-LEAF  
 262WHL005MS-00

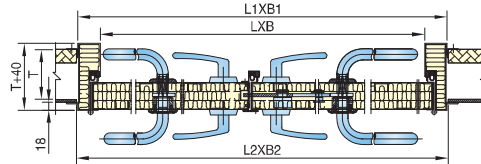
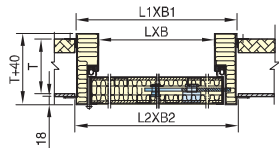
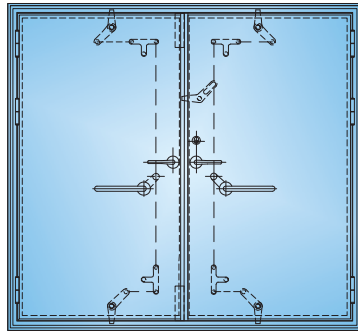

类型 TYPE	通孔尺寸 SIZE OF DOORWAY LXB	门框尺寸 FRAME SIZE L1XB1	围壁开孔尺寸 SIZE OF B.H.OPENING L2XB2	重量 WEIGHT KG	选择项 OPTION
单扇 SINGLE LEAF 262WHL005M-00	1600X600	1700X700	1705X705	118	闭门器 定门器 DOOR CLOSER DOOR STOPPER
	1650X650	1750X750	1755X755	128	
	1700X700	1800X800	1805X805	142	
	1750X800	1850X900	1855X905	149	
	1900X900	2000X1000	2005X1005	162	
双扇 DOUBLE LEAF 262WHL005MS-00	1600X1000	1700X1100	1705X1105	172	DOOR CLOSER DOOR STOPPER
	1650X1100	1750X1200	1755X1205	184	
	1700X1300	1800X1400	1805X1405	230	
	1750X1600	1850X1700	1855X1705	280	
	2000X1850	2100X1950	2105X1955	324	

标记示例:

通孔尺寸为1600X600 A60单扇风雨密气密门(左外开式)

(舱室A型)A60单扇风雨密气密门 A601600X600-6.1 262WHL005M-00

通孔尺寸为1600X1000 A60双扇风雨密气密门(双外开)

(舱室A型)A60双扇风雨密气密门 A601600X1000-5.1 & 6.1 262WHL005MS-00



舰船装备 出类拔萃 海联产品 情联四海

**(舱室B型)A60风雨密气密门(单扇, 双扇)**  
**(TYPE B FOR CABIN)A60 WEATHERTIGHT AND GASTIGHT DOOR (SINGLE-LEAF,DOUBLE-LEAF)**

262WHL653-00  
 262WHL651-00

单扇 SINGLE-LEAF  
 262WHL653-00

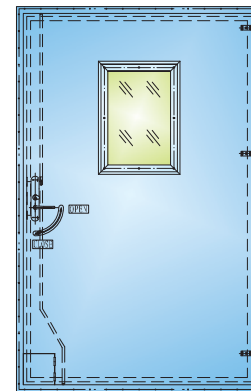

双扇 DOUBLE-LEAF  
 262WHL651-00

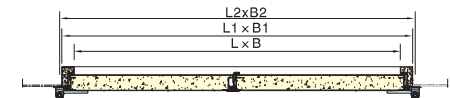
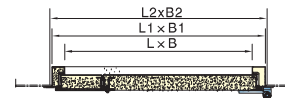
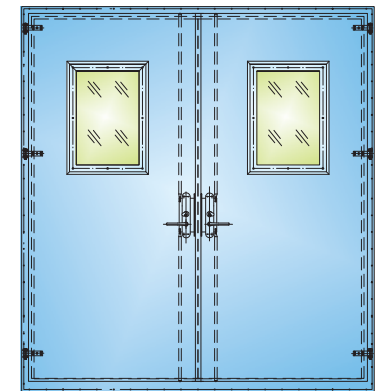

类型 TYPE	通孔尺寸 SIZE OF DOORWAY LXB	门框尺寸 FRAME SIZE L1XB1	围壁开孔尺寸 SIZE OF B.H.OPENING L2XB2	重量 WEIGHT KG	选择项 OPTION
单扇 SINGLE LEAF 262WHL653-00	1600X600	1696X696	1700X700	116	闭门器 定门器 DOOR CLOSER DOOR STOPPER
	1650X650	1746X746	1750X750	123	
	1700X700	1796X796	1800X800	133	
	1750X800	1846X896	1850X900	145	
	2400X1400	2496X1496	2500X1500	276	
双扇 DOUBLE LEAF 262WHL651-00	1600X1000	1696X1096	1700X1100	174	DOOR CLOSER DOOR STOPPER
	1650X1100	1746X1196	1750X1200	187	
	1700X1300	1796X1396	1800X1400	213	
	1750X1600	1846X1696	1850X1700	249	
	2500X2300	2596X2396	2600X2400	427	

标记示例:

通孔尺寸为1600X600 A60单扇风雨密气密门(右外开式)

(舱室B型)A60单扇风雨密气密门 A601600X600-5.1 262WHL653-00

通孔尺寸为1600X1000 A60双扇风雨密气密门(双外开)

(舱室B型)A60双扇风雨密气密门 A601600X1000-5.1&6.1 262WHL651-00



舰船装备 出类拔萃 海联产品 情联四海

## 驾驶室移门 SLIDING DOOR FOR WHEELHOUSE

262WHL055-00  
(参照CBM2055-82)

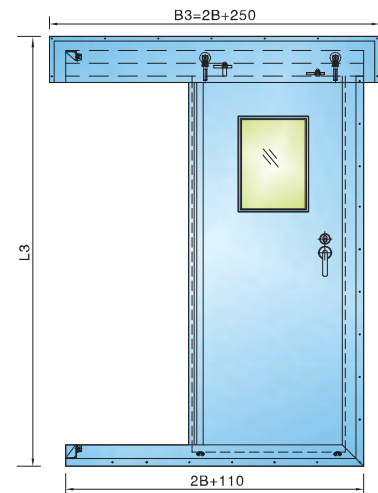

本产品按照ISO国际标准设计制造,具有噪音小、外形美观、开闭轻便等优点,适合各类船舶使用。

THIS PRODUCT IS MADE IN ACCORDANCE WITH ISO STANDARD, WITH MERITS OF LOW NOISE, FINE APPEARANCE AND LIGHTY, WHICH CAN BE USED FOR VARIOUS KINDS OF SHIPS.

A	全不锈钢 STAINLESS STEEL
B	全铝质 ALUMINIUM
C	门页铝质其它钢质 ALUMINIUM DOOR BOARD, OTHER STEEL

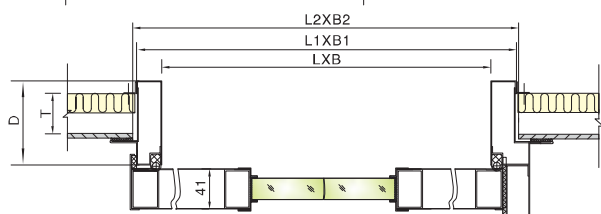

类型 TYPE	通孔尺寸 SIZE OF DOORWAY LXB	门框尺寸 FRAME SIZE L1XB1	围壁开口 SIZE OF B.H. OPENING L2XB2	外形尺寸 SIZE OF OUTLINE L3XB3	D	开向 OPENING	重量 WEIGHT(KG)		
							A	B	C
A	1700X750	1780X830	1785X835	2100X1750	T+70	左 L	56	42	40
							62	48	46
							66	52	50
B	1700X900	1780X980	1785X985	2100X2050		右 R	66	52	50
							72	58	56
C	1800X900	1880X980	1885X985	2200X2050					
	1800X1000	1880X1080	1885X1085	2200X2250					

标记示例:

通孔尺寸为1800X900mm 框深D为200左移式, A型驾驶室移门

驾驶室移门 A1800X900-200L 262WHL055-00



舰船装备 出类拔萃 海联产品 情联四海

## 不锈钢/铝质单扇舱室移门 STAINLESS STEEL/ALUMINIUM SINGLE-LEAF SLIDING DOOR FOR CABIN

262WHL035C-00

适用于船舱上层建筑内部舱室门,表面阳极氧化或贴膜处理  
USED FOR THE CABIN INSIDE SHIP SUPERSTRUCTURE.THE SURFACE OF DOOR IS OXIDED OR PVC COVERED.

单扇(S)  
SINGLE

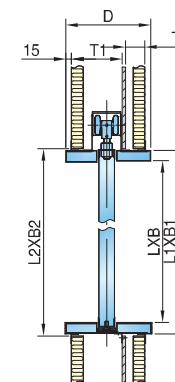
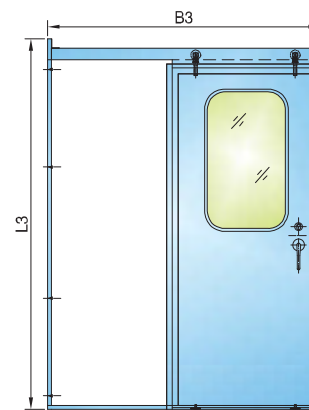

N	不锈钢 STAINLESS STEEL
L	铝质 ALUMINIUM

A: 基本型 BASE MODE

B: 带方窗 WITH FIXED LIGHT

C: 带风栅应急通孔  
WITH VENTILATOR ESCAPE HOLE

D: 带方窗和风栅应急通孔  
WITH FIXED LIGHT & VENT ESCAPE EXIT

类型 TYPE	通孔尺寸 SIZE OF DOORWAY LXB	门框尺寸 FRAME SIZE L1XB1	围壁开口尺寸 SIZE OF B.H. OPENING L2XB2	外形尺寸 SIZE OF DOOR L3XB3	框深 D ≥76	开向 OPENING	重量 WEIGHT KG									
							铝质 ALUMINIUM				不锈钢 STAINLESS STEEL					
							A	B	C	D	A	B	C	D		
单扇 SINGLE	A	1600X600	1660X660	1665X665	1760X1200	T1+T2+35	左 L	29	31	31	33	75	77	77	79	
								31	33	33	35	81	83	83	85	
								33	35	35	37	86	88	88	90	
	B	1750X700	1810X760	1815X765	1910X1400			右 R	36	38	38	40	94	96	96	98
									57	61	61	65	148	152	152	156
									61	65	65	69	159	163	163	167
C	1600X1200	1660X1260	1665X1265	1760X2400	左 L	65	69		69	73	169	173	173	177		
						61	65		65	69	159	163	163	167		
						65	69		69	73	169	173	173	177		
D	1750X1400	1810X1460	1815X1465	1910X2800		右 R	71	75	75	79	185	185	189	193		
							65	69	69	73	169	173	173	177		
							71	75	75	79	185	185	189	193		

标记示例:

通孔尺寸为1600X600,框深D为200,左移式,带方窗单扇铝质舱室移门

铝质单扇舱室移门 SL-B1600X600-200L 262WHL035-00



舰船装备 出类拔萃 海联产品 情联四海

不锈钢/铝质舱室双扇移门  
STAINLESS STEEL/ALUMINIUM DOUBLE-LEAF SLIDING DOOR FOR CABIN

262WHL035A-00

双扇 (D)  
DOUBLE

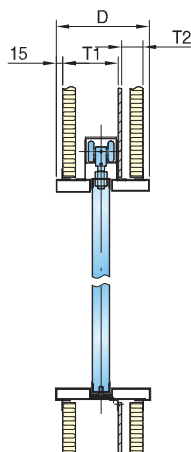
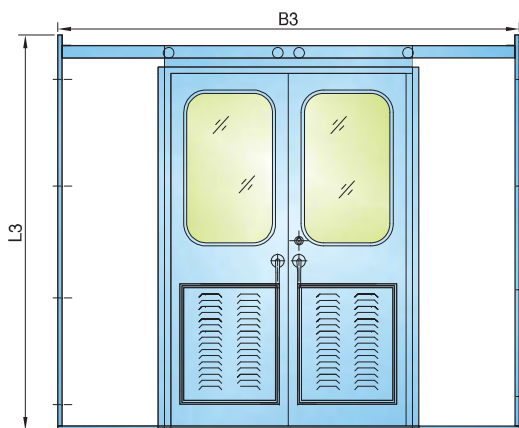

- A: 基本型 BASE MODE
- B: 带方窗 WITH FIXED LIGHT
- C: 带风栅应急通风孔 WITH VENTILATOR ESCAPE HOLE
- D: 带方窗和风栅应急通风孔 WITH FIXED LIGHT & VENT ESCAPE EXIT

N	不锈钢 STAINLESS STEEL
L	铝质 ALUMINIUM

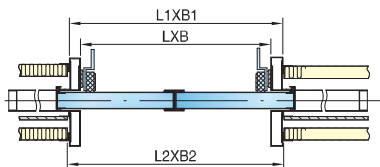

类型 TYPE	通孔尺寸 SIZE OF DOORWAY LXB	门框尺寸 FRAME SIZE L1XB1	围壁开口尺寸 SIZE OF B.H. OPENING L2XB2	外形尺寸 SIZE OF OUTLINE L3XB3	框深 D ≥76	重量 WEIGHT KG							
						铝质 ALUMINIUM				不锈钢 STAINLESS STEEL			
						A	B	C	D	A	B	C	D
双扇 DOUBLE	A	1600X1200	1660X1260	1665X1265	1760X2360	63	71	71	79	163	171	171	179
	B	1650X1300	1710X1360	1715X1365	1810X2560	67	75	75	83	175	183	183	191
	C	1750X1400	1810X1460	1815X1465	1910X2760	72	80	80	88	186	194	194	202
	D	1750X1600	1810X1660	1815X1665	1910X3160	78	86	86	94	204	212	212	220

标记示例:

通孔尺寸为1600X1200,框深D为250,带方窗和风栅应急通风孔双扇不锈钢舱室移门  
不锈钢双扇舱室移门 DN-D1600X1200-250 262WHL035-00



舰船装备 出类拔萃 海联产品 情联四海

铝质驾驶室防风雨移门  
ALUMINIUM ALLOY SPRAYTIGHT SLIDING DOOR FOR WHEELHOUSE

262WHL056-00

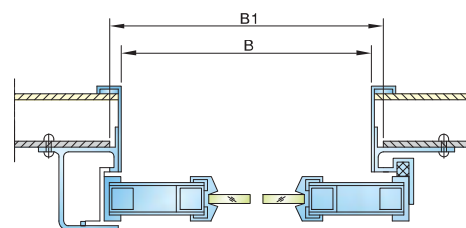
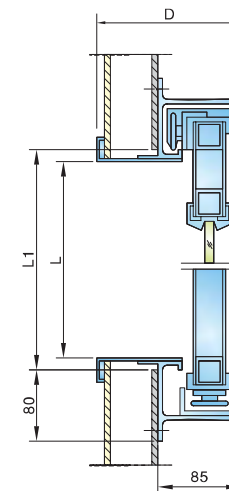
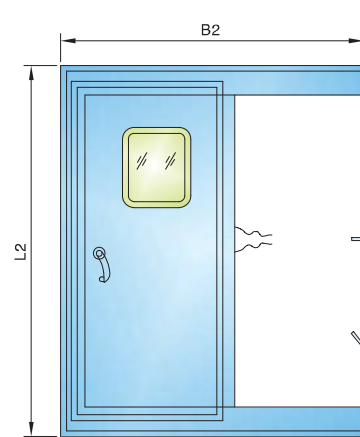

通孔尺寸 SIZE OF DOORWAY LXB	围壁开孔 SIZE OF B.H. OPENING L1XB1	外形尺寸 SIZE OF OUTLINE L2XB2	D	开向 OPENING	重量 WEIGHT KG
1700X750	1715X765	1875X1530	90-200	左 L	42.1
1700X900	1715X915	1875X1830			48.3
1800X900	1815X915	1975X1830		右 R	52.4
1800X1000	1815X1015	1975X2030			58.7

标记示例:

通孔尺寸为1700X900 D为90右移铝质驾驶室防风雨移门  
铝质驾驶室防风雨移门 L-1700X900-90R 262WHL056-00





舰船装备 出类拔萃 海联产品 情联四海

### 铝质/不锈钢风雨密外围壁门(单、双) ALUMINIUM/STAINLESS STEEL WEATHERTIGHT DOOR FOR WEATHER WALL (SINGLE/DOUBLE)

262WHL044A/B-00

适用于船舶上层建筑外门，具有良好风雨密性和气密性。  
USED FOR ENTRANCE DOOR OF SHIP SUPER STRUCTURE,  
WHICH HAS GOOD WEATHERTIGHTNESS AND GASTIGHTNESS.

N	不锈钢 STAINLESS STEEL
L	铝质 ALUMINIUM

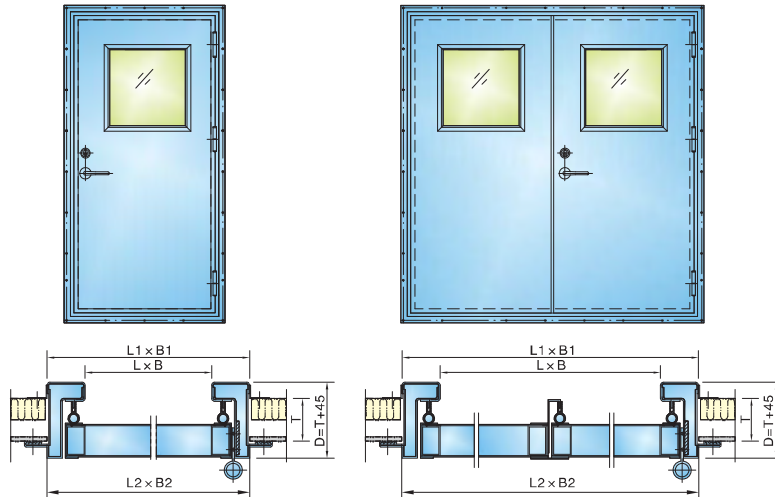

类型 TYPE	通孔尺寸 SIZE OF DOORWAY LXB	门框尺寸 SIZE OF FRAME L1XB1	围壁开孔尺寸 SIZE OF B.H. OPENING L2XB2	框深 DEPTH OF FRAME D >80	开向 OPENING	重量 (KG) WEIGHT				选择项 OPTION
						铝质 ALUMINIUM		不锈钢 STAINLESS STEEL		
单扇 SINGLE 262WHL044A-00	1600X600	1695X695	1700X700	T+45	右外 RO	32	31	75	74	方窗 PORT LIGHT 闭门器 DOOR CLOSER 定门器 DOOR STOPPER
	1600X800	1695X895	1700X900			36	35	82	35	
	1700X700	1795X795	1800X800			35	34	78	34	
	1800X800	1895X895	1900X900			38	37	85	37	
双扇 DOUBLE 262WHL044B-00	1600X1000	1695X1095	1700X1100	T+45	左外 LO	53	52	123	125	
	1600X1200	1695X1295	1700X1300			61	60	142	144	
	1800X1600	1895X1695	1900X1700			81	80	190	192	

标记示例:

通孔尺寸为1600X600, 框深100mm, 带窗单扇不锈钢风雨密外围壁门(右外开式)

单扇不锈钢风雨密外围壁门 N-1600X600-100RO 260WHL044A-00

通孔尺寸为1600X1200, 框深100mm, 不带窗双扇铝质风雨密外围壁门

双扇铝质风雨密外围壁门 L-1600X1200-100 262WHL044B-00



舰船装备 出类拔萃 海联产品 情联四海

### 玻璃钢风雨密门 GRP WEATHERTIGHT DOOR

262WHL045-00

本产品采用玻璃钢门页，钢质或不锈钢门框，防风雨性能好，适用于上层建筑外门。  
THE PRODUCT HAS GRP DOOR LEAF AND STEEL OR STAINLESS STEEL DOOR FRAME,  
AS WELL AS GOOD WEATHERTIGHTNESS ,USED FOR OUTSIDE DOOR OF SUPERSTRUCTURE.

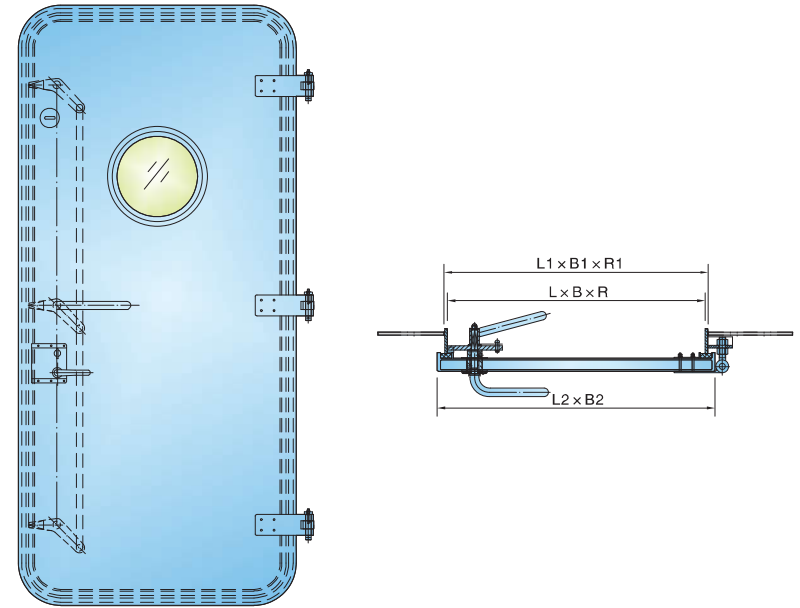

通孔尺寸 SIZE OF DOORWAY LXB	围壁开孔 SIZE OF B.H. OPENING L1XB1	外形尺寸 SIZE OF DOOR L2XB2	开向 OPENING	重量 WEIGHT KG	选择项 OPTION
1650X600XR100	1670X620XR110	1713X663	右外 RO	88	圆窗 PORT LIGHT 闭门器 DOOR CLOSER 定门器 DOOR STOPPER
1700X700XR100	1720X720XR110	1763X763		95	
1750X750XR100	1770X770XR110	1813X813	左外 LO	101	
1800X800XR100	1820X820XR110	1863X863		107	

标记示例:

通孔尺寸为1700X700, 右外开, 玻璃钢风雨密门

玻璃钢风雨密门 1700X700-RO 262WHL045-00



舰船装备 出类拔萃 海联产品 情联四海

**A60 防火移门**  
**A60 FIREPROOF SLIDING DOOR**

262WHL008F-00

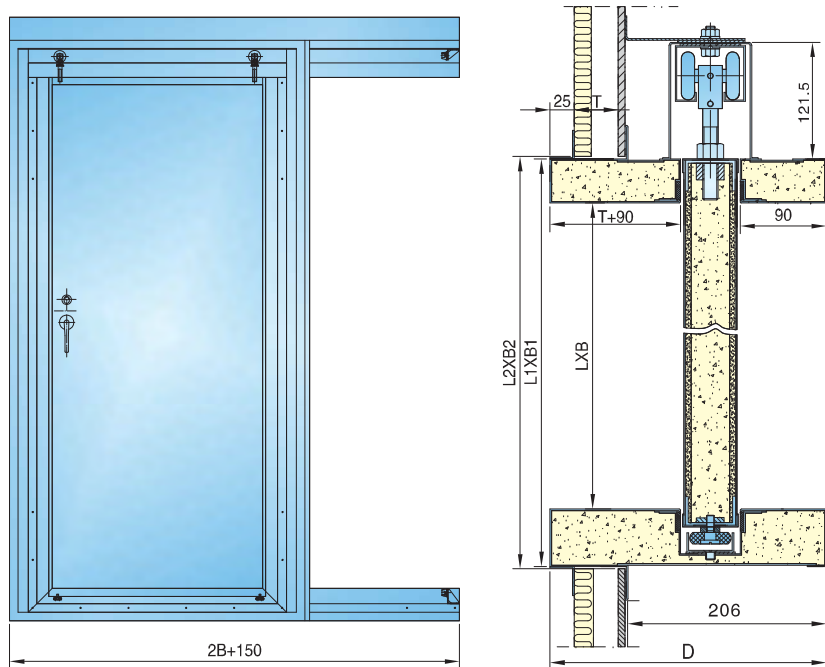

通孔尺寸 SIZE OF DOORWAY LXB	门框外形尺寸 SIZE OF OUTLINE L1XB1	围壁开口尺寸 SIZE OF B.H. OPENING L2XB2	D	开向 OPENING	重量 WEIGHT KG
1700X700	1820X820	1825X825	T+241	右 R	150
1750X750	1870X870	1875X875			170
1800X800	1920X920	1925X925		左 L	187
2075X1875	2195X1995	2200X2000			293

标记示例:

通孔尺寸为1700X700,D为350,右移A60防火移门

A60防火移门 A60-1700X700-350R 262WHL008F-00



舰船装备 出类拔萃 海联产品 情联四海

**H120防火移门**  
**H120 FIREPROOF SLIDING DOOR**

262WHL008F(120)-00

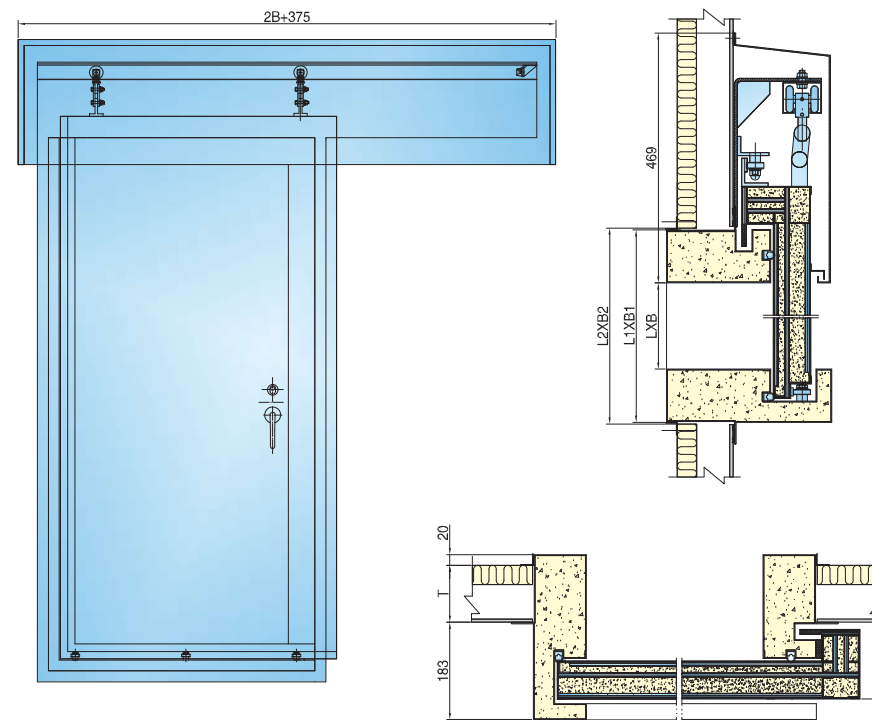

通孔尺寸 SIZE OF DOORWAY LXB	门框外形尺寸 SIZE OF OUTLINE L1XB1	围壁开口尺寸 SIZE OF B.H. OPENING L2XB2	D	开向 OPENING	重量 WEIGHT KG
1700X700	1900X900	1905X905	T+203	右 R	180
1750X750	1950X950	1955X955			204
1800X800	2000X1000	2005X1005		左 L	224
1900X900	2100X1100	2105X1105			264

标记示例:

通孔尺寸为1700X700, D为300, 右移H120防火移门

H120防火移门 H120-1700X700-300R 262WHL008F(120)-00



舰船装备 出类拔萃 海联产品 情联四海

单扇防火门  
SINGLE LEAF FIREPROOF DOOR

CB\*3234-84

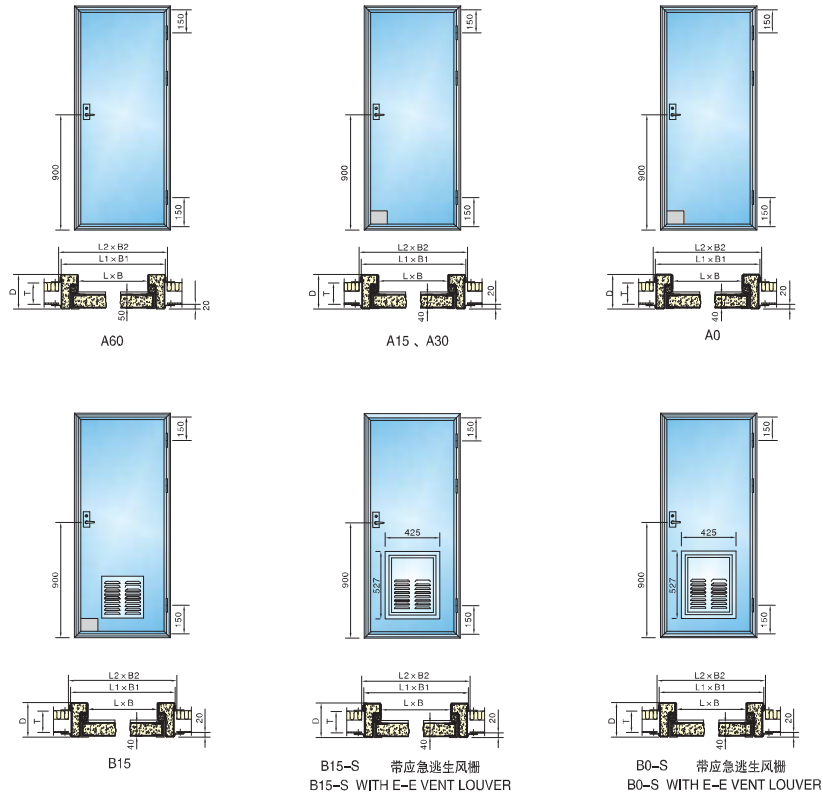

等级 CLASS	分类 SUBDIVISION	开向 OPENING
A级 CLASS A	A60	左内 LI (ZN) 左外 LO (ZW) 右内 RI (YN) 右外 RO (YW)
	A30	
	A15	
	A0	
B级 CLASS B	B15	
	B15-S	
	B0-S	

适应舱壁 SUIT THE BULKHEAD

A	一道钢围壁	
B	一道钢围壁 一道装饰壁	
C	一道钢围壁 二道装饰壁	



舰船装备 出类拔萃 海联产品 情联四海

单扇防火门  
SINGLE LEAF FIREPROOF DOOR

CB\*3234-84

等级 CLASS	通孔尺寸 SIZE OF DOORWAY LXB	门框尺寸 FRAME SIZE L1XB1	围壁开口 SIZE OF B.H. OPENING L2XB2	T	D	重量 KG			
						A0	A15	A30	A60
A级 CLASS A	1650X600	1750X700	1755X705	由设计者定 DECIDED BY DESIGNER	T+45	61.75	88.08	106.53	112.26
	1650X650	1750X750	1755X755			64.51	92.87	111.71	117.83
	1650X700	1750X800	1755X805			67.02	97.4	116.99	123.52
	1650X750	1750X850	1755X855			69.7	102.1	122.17	129.09
	1650X800	1750X900	1755X905			72.29	106.72	127.35	134.68
	1700X600	1800X700	1805X705			63.29	90.41	109.33	115.21
	1700X650	1800X750	1805X755			66.02	95.21	114.71	121.01
	1700X700	1800X800	1805X805			66.77	100.06	120.03	126.74
	1700X750	1800X850	1805X855			71.41	104.77	125.31	132.44
	1750X750	1850X850	1855X855			73.2	107.51	128.44	135.76
	1750X800	1850X900	1855X905			76	112.46	133.87	141.61
	1800X600	1900X700	1905X705			66.53	95.2	114.96	121
	1800X650	1900X750	1905X755			69.29	100.15	120.46	121.14
	1800X700	1900X800	1905X805			72.16	105.23	126.06	133.14
	1800X750	1900X850	1905X855			75	110.27	131.58	139.1
	1800X800	1900X900	1905X905			77.87	115.35	137.56	145.5
	1850X600	1950X700	1955X705			68.05	97.48	117.7	124.08
	1850X650	1950X750	1955X755			70.97	102.66	123.38	130.2
1850X700	1950X800	1955X805	73.89	107.84	129.06	136.32			
1850X750	1950X850	1955X855	76.81	113.03	135.14	142.84			
1850X800	1950X900	1955X905	79.62	118.1	140.5	148.65			

等级 CLASS	通孔尺寸 SIZE OF DOORWAY LXB	门框尺寸 FRAME SIZE L1XB1	围壁开口 SIZE OF B.H. OPENING L2XB2	T	D	重量 KG	
						B0	B15
B级 CLASS B	1650X600	1730X680	1735X685	由设计者定 DECIDED BY DESIGNER	T+45	55.88	95.01
	1650X650	1730X730	1735X735			58.64	100.1
	1650X700	1730X780	1735X785			61.15	104.93
	1650X750	1730X830	1735X835			63.83	109.94
	1650X800	1730X880	1735X885			66.42	114.85
	1700X600	1780X680	1785X685			57.24	97.46
	1700X650	1780X730	1785X735			59.97	102.56
	1700X700	1780X780	1785X785			62.72	107.71
	1700X750	1780X830	1785X835			65.36	112.72
	1700X800	1780X880	1785X885			68.11	117.77
	1750X600	1830X680	1835X685			58.67	99.95
	1750X650	1830X730	1835X735			61.47	105.19
	1750X700	1830X780	1835X785			64.18	110.35
	1750X750	1830X830	1835X835			66.98	115.49
	1750X800	1830X880	1835X885			69.78	120.74
	1800X600	1880X680	1885X685			60.13	102.51
	1800X650	1880X730	1885X735			62.89	107.75
	1800X700	1880X780	1885X785			65.76	113.03
1800X750	1880X830	1885X835	68.6	118.37			
1800X800	1880X880	1885X885	71.47	123.95			
1850X600	1930X680	1935X685	61.47	104.9			
1850X650	1930X730	1935X735	64.39	110.28			
1850X700	1930X780	1935X785	67.31	115.76			
1850X750	1930X830	1935X835	70.23	121.45			
1850X800	1930X880	1935X885	73.04	126.62			

注：防火门可以根据客户要求装配门碰、闭门器。

NOTE: STOPPER, DOOR CLOSERS COULD BE EQUIPPED ACC TO CUSTOMER'S REQUIREMENTS.

标记示例：

通孔尺寸为1650X650 A15级左外开一道钢围壁一道装饰壁的单扇防火门

单扇防火门 A15(LO)-B1650X650 CB\*3234-84

通孔尺寸为1800X750 B15级带应急逃生风栅右内开一道钢围壁二道装饰壁的单扇防火门

单扇防火门 B15-S(RI)-C 1800X750mm CB\*3234-84



舰船装备 出类拔萃 海联产品 情联四海

**A级带方窗/消防小门防火门**  
**CLASS A FIREPROOF DOOR WITH SQUARE WINDOW/HOSE PORT**

262WHL016-00 A0  
 262WHL016B-00 A30  
 262WHL005A-00 A60  
 262WHL660-00 A60

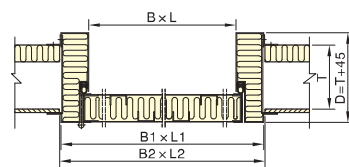
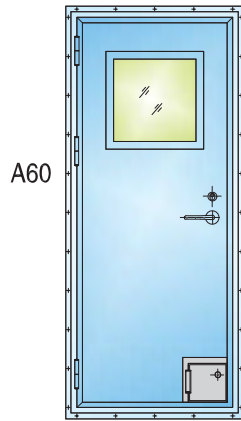
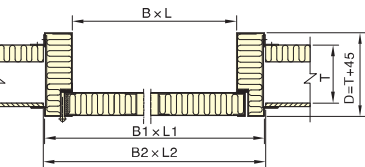
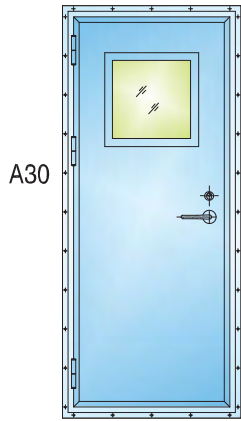

通孔尺寸 SIZE OF DOORWAY BXL	门框尺寸 FRAME SIZE B1XL1	围壁开孔尺寸 SIZE OF B.H. OPENING B2XL2	重量 WEIGHT KG
600X1650	700X1750	705X1755	92
650X1650	750X1750	755X1755	97
700X1650	800X1750	805X1755	102
600X1700	700X1800	705X1805	95
650X1700	750X1800	755X1805	98
700X1700	800X1800	805X1805	101
700X1750	800X1850	805X1855	104
1400X2300	1500X2400	1505X2405	221

注：重量为D=100mm，A60门的计算结果。

THE WEIGHT IS CALCULATED FOR A60 DOOR AT D=100mm.

图号 DWG.NO.	名称 DESCRIPTION	选择项 OPTION	
		方窗 WINDOW	消防小门 HOSE PORT
262WHL016-00	A0级防火门 A0 FIRE PROOF DOOR	○	●
262WHL016B-00	A30级防火门 A30 FIRE PROOF DOOR	●	○
262WHL005A-00	A60级防火门 A60 FIRE PROOF DOOR	●	●
262WHL660-00	A60级防火门 A60 FIRE PROOF DOOR	●	●

注：防火门可以根据客户要求装配门碰、闭门器。

NOTE: STOPPER, DOOR CLOSERS COULD BE EQUIPPED ACC. TO CUSTOMER'S REQUIREMENTS.

标记示例：

通孔尺寸为650X1650 A60级左外开一道钢围壁一道装饰壁的带窗防火门  
 单扇防火门 A60(LO)-B-650X1650 262WHL005A-00



舰船装备 出类拔萃 海联产品 情联四海

**B15级防火门(带窗和逃生口)**  
**B15 FIREPROOF DOOR WITH WINDOW AND EMERGENCY EXIT**

262WHL673-00

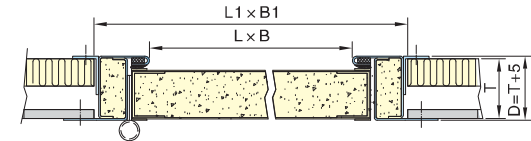
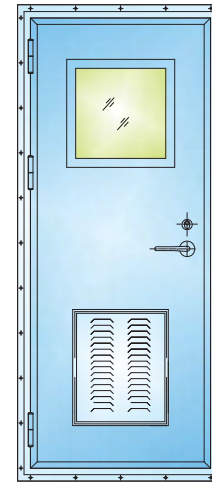

通孔尺寸 SIZE OF DOORWAY BXL	围壁开孔尺寸 SIZE OF B.H. OPENING B2XL2	重量 WEIGHT KG	选择项 OPTION
600X1650	685X1735	62	方窗 应急出口 通风栅 闭门器 定门器
650X1650	735X1735	65	
700X1650	785X1735	68	
600X1700	685X1785	65	
650X1700	735X1785	68	PORT LIGHT EMERGENCY EXIT VENT DOOR CLOSER DOOR STOPPER
700X1700	785X1785	71	
1200X2300	1285X2385	128	

注：重量(D=100mm时)计算结果。

THE WEIGHT IS CALCULATED (AT D=100mm).

标记示例：

通孔尺寸为650X1650 B15级左外开一道钢围壁一道装饰壁的带方窗和逃生口的防火门  
 防火门 B15-650X1650(带方窗和逃生口) 262WHL673-00



舰船装备 出类拔萃 海联产品 情联四海

**A60级双扇防火门(带消防小门)** **262WHL005S-00**  
**A60 CLASS DOUBLE LEAVES FIREPROOF DOOR (WITH SMALL FIRE FIGHTING DOOR)**

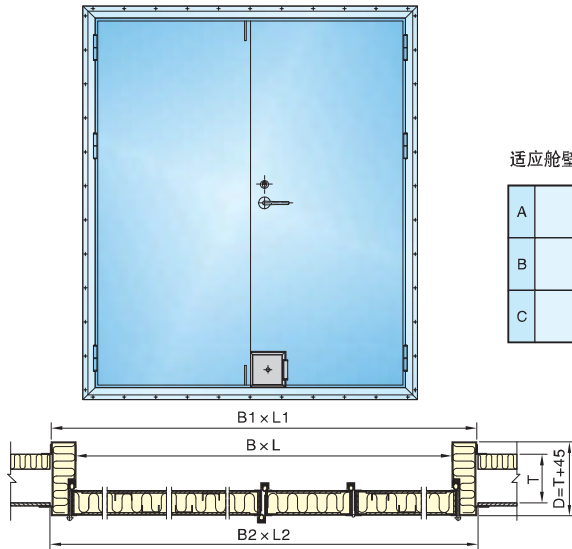

适应舱壁 SUIT THE BULKHEAD

A	一道钢围壁	
B	一道钢围壁 一道装饰壁	
C	一道钢围壁 二道装饰壁	

通孔尺寸 SIZE OF DOORWAY BXL	门框尺寸 FRAME SIZE B1XL1	围壁开孔尺寸 SIZE OF B.H. OPENING B2XL2	重量 WEIGHT KG	选择项 OPTION
1200X1700	1294X1794	1300X1800	142	闭门器
1300X1700	1394X1794	1400X1800	148	
1400X1700	1494X1794	1500X1800	154	
1100X1750	1194X1844	1200X1850	150	消防小门
1200X1750	1294X1844	1300X1850	157	DOOR CLOSER
1300X1750	1394X1844	1400X1850	164	DOOR STOPPER
1400X1750	1494X1844	1500X1850	171	HOSE PORT
1550X1850	1644X1944	1650X1950	196	

标记示例:

通孔尺寸为1200X1700一道钢围壁一道装饰壁A60级双扇防火门  
 A60级双扇防火门 A60-B-1200X1700 262WHL005S-00

注:重量(D=100mm时)计算结果。  
 THE WEIGHT IS CALCULATED (AT D=100mm).



舰船装备 出类拔萃 海联产品 情联四海

**H30b铝质防火门** **262WHL004B-00ST**  
**H30b ALUMINIUM FIREPROOF DOOR**

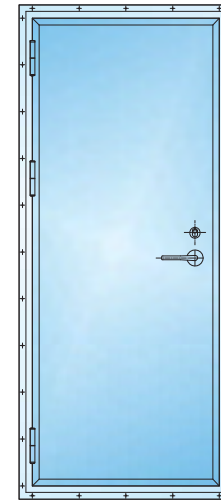

适应舱壁 SUIT THE BULKHEAD

A	一道钢围壁	
B	一道钢围壁 一道装饰壁	
C	一道钢围壁 二道装饰壁	

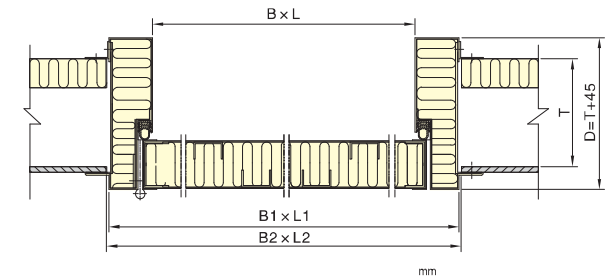

通孔尺寸 SIZE OF DOORWAY BXL	门框尺寸 FRAME SIZE B1XL1	围壁开孔尺寸 SIZE OF B.H. OPENING B2XL2	重量 WEIGHT KG	选择项 OPTION
600X1650	700X1750	705X1755	46	闭门器
650X1650	750X1750	755X1755	48	
700X1650	800X1750	805X1755	50	
600X1700	700X1800	705X1805	47	定门器
650X1700	750X1800	755X1805	49	DOOR CLOSER
700X1700	800X1800	805X1805	51	DOOR STOPPER
700X1750	800X1850	805X1855	53	
800X1850	900X1950	905X1955	59	

注:重量(D=100mm)时计算结果。  
 THE WEIGHT IS CALCULATED AT D=100mm.

标记示例:

通孔尺寸为600X1650左外开一道钢围壁一道装饰壁的H30b铝质防火门  
 H30b铝质防火门 H30b(LO)-B-600X1650 262WHL004B-00ST



舰船装备 出类拔萃 海联产品 情联四海

**A0,A30级防火防盗门**  
**A0,A30 FIREPROOF ANTI-THEFT DOOR**

**262WHL004FD-00**

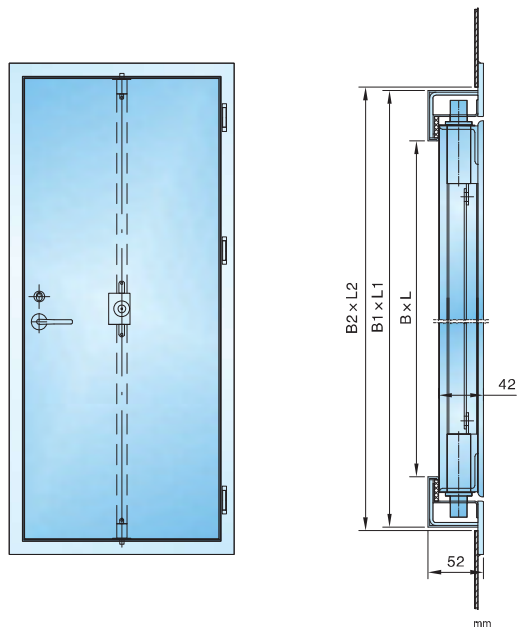

通孔尺寸 SIZE OF DOORWAY BXL	门框尺寸 FRAME SIZE B1XL1	围壁开孔尺寸 SIZE OF B.H. OPNING B2XL2	重量 KG WEIGHT	
			A0	A30
600X1650	700X1750	705X1755	74	80
650X1650	750X1750	755X1755	79	84
700X1650	800X1750	805X1755	84	88
600X1700	700X1800	705X1805	77	83
650X1700	750X1800	755X1805	80	86
700X1700	800X1800	805X1805	83	89
700X1750	800X1850	805X1855	87	91

标记示例:

通孔尺寸为650X1650右外开的A30防火防盗门  
防火防盗门 A30(RO)-650X1650 262WHL004FD-00



舰船装备 出类拔萃 海联产品 情联四海

**钢质隔音阻气门**  
**STEEL SOUNDPROOF GAS-RETARDING DOOR**

**CB\*3217-84**

适用于机舱控制室等部位。

USED FOR ENGINE CONTROL ROOM AND SO ON.

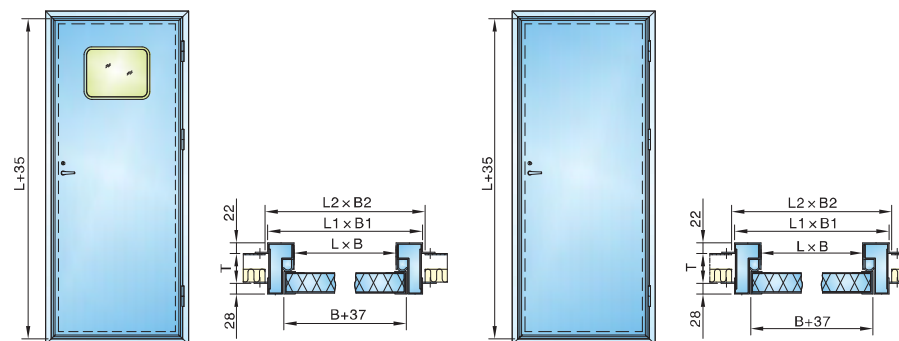

类型 TYPE	通孔尺寸 SIZE OF DOORWAY LXB	门框尺寸 FRAME SIZE L1XB1	围壁开孔尺寸 SIZE OF B.H. OPNING L2XB2	D	开向 OPENING	重量 WEIGHT KG	
A AZ	1650X600	1743X693	1750X700	≥80	左外 LO	68	
	1750X700	1843X793	1850X800			73	
	1650X800	1743X893	1750X900			73	
B BZ	1650X600	1743X693	1750X700		T+50	右外 RO	81.5
	1750X700	1843X793	1850X800				86.5
	1650X800	1743X893	1750X900				89.9
C CZ	1650X600	1743X693	1750X700	T+50		左内 LI	81.5
	1750X700	1843X793	1850X800				86.5
	1650X800	1743X893	1750X900				85

A	不带窗 WITHOUT LIGHT	单层壁 USED FOR SINGLE WALL
AZ	带双层窗 WITH DOUBLE LIGHT	
B	不带窗 WITHOUT LIGHT	双层壁 USED FOR DOUBLE WALLS
BZ	带双层窗 WITH DOUBLE LIGHT	
C	不带窗 WITHOUT LIGHT	三层壁 USED FOR THREE WALLS
CZ	带双层窗 WITH DOUBLE LIGHT	

标记示例:

通孔尺寸为1750X700mm框深D为100,左内开,带双层窗,一道钢围壁一道装饰壁的钢质隔音阻气门  
钢质隔音阻气门 BZ1750X700-100LI CB\*3217-84



舰船装备 出类拔萃 海联产品 情联四海

## 铝质舱室空腹门 ALUMINIUM HOLLOW CABIN DOOR

CB/T3281-1997

适用于各类船舶、舰艇室，表面阳极氧化静电喷塑和复塑处理。

USED FOR CABIN OF VARIOUS KINDS OF SHIP AND WAR SHIPS,

THE DOOR SURFACE WILL BE ANODIZED BAKING FINISHED OR PVC COVERED.

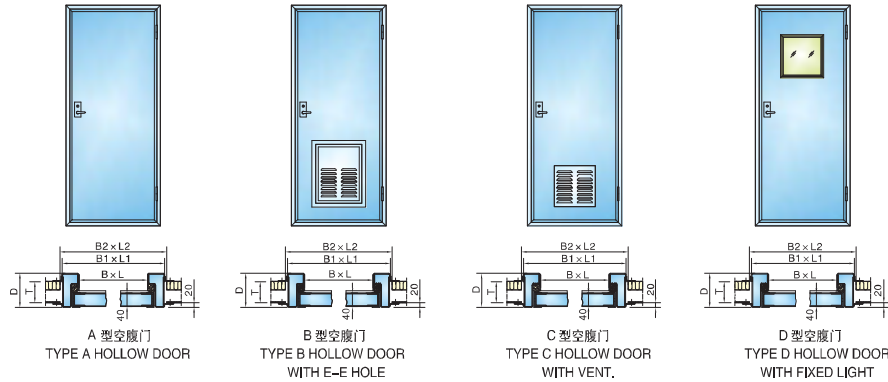

等级 CLASS	开向 OPENING	通孔尺寸 SIZE OF DOORWAY BXL	门框尺寸 FRAME SIZE B1XL1	开孔尺寸 SIZE OF B.H. OPENING B2XL2	D (≥75)	重量 WEIGHT KG
A	左外 LO	600X1600	680X1680	686X1686	T+45	23.6
		650X1650	730X1730	736X1736		24.97
		700X1750	780X1830	786X1836		26.83
		800X1750	880X1830	886X1836		28.62
B	右外 RO	600X1600	680X1680	686X1686		34.51
		650X1650	730X1730	736X1736		35.88
		700X1750	780X1830	786X1836		37.78
		800X1750	880X1830	886X1836		39.71
C	左内 LI	600X1600	680X1680	686X1686		24.61
		650X1650	730X1730	736X1736		26
D	右内 RI	700X1750	780X1830	786X1836		27.87
		800X1750	880X1830	886X1836		29.76
		600X1600	680X1680	686X1686		26.72
		650X1650	730X1730	736X1736		28.41
		700X1750	780X1830	786X1836		29.8
		800X1750	880X1830	886X1836		31.73

门框型式 FRAME TYPE	代号 CODE
定型材料 STANDARD	K1
折边 FLANG TYPE	K2

标记示例:

通孔尺寸为650X1650 D为150, 右外开, B型, 门框为定型材料的铝质舱室空腹门

铝质舱室空腹门 B650X1650X150RO-K1 CB/T3281-1997



舰船装备 出类拔萃 海联产品 情联四海

## 钢质隔声门 STEEL SOUND PROOF DOOR

262WHL009G-00

隔声值 47dB(A)

SOUND REDUCE VALUE 47 dB(A)

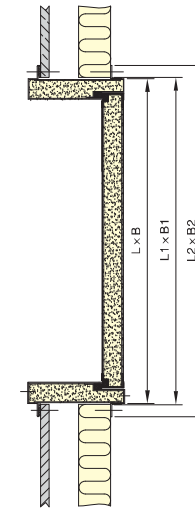
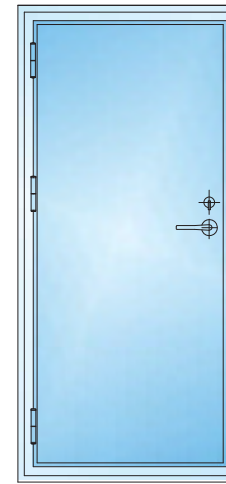

类型 TYPE	
名称 DESCRIPTION	符号 CODE
一层壁不带窗 USED FOR SINGLE WALL AND WITHOUT LIGHT	A
一层壁带窗 USED FOR SINGLE WALL AND WITH LIGHT	AZ
二层壁不带窗 USED FOR DOUBLE WALLS AND WITHOUT LIGHT	B
二层壁带窗 USED FOR DOUBLE WALLS AND WITH LIGHT	BZ
三层壁不带窗 USED FOR THREE WALLS AND WITHOUT LIGHT	C
三层壁带窗 USED FOR THREE WALLS AND WITH LIGHT	CZ

标记示例:

通孔尺寸为1650X800, 框深为100, 右内开, 带双层窗, 一道钢围壁一道装饰壁的钢质隔声门

钢质隔声门 BZ1650X800-100RI 262WHL009G-00

通孔尺寸 DOORWAY SIZE L x B	门框尺寸 FRAME SIZE L1 x B1	围壁开孔尺寸 OPENING SIZE L2 x B2	重量 WEIGHT KG	选项 OPTION
1400X600	1494X694	1500X700	60	前门 闭门器 方窗 DOOR CLOSER DOOR STOPPER PORT LIGHT
1600X600	1694X694	1700X700	66	
1800X750	1894X844	1900X850	76.5	



舰船装备 出类拔萃 海联产品 情联四海

### 铝质隔声门 ALUMINIUM SOUND PROOF DOOR

262WHL009A-00  
262WHL009T-00

262WHL009A-00  
隔声值 37dB  
SOUND PROOF VALUE 37 dB

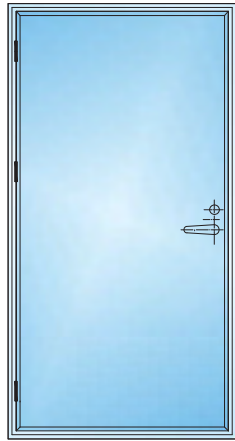

262WHL009T-00  
隔声值 35dB  
SOUND PROOF VALUE 35 dB

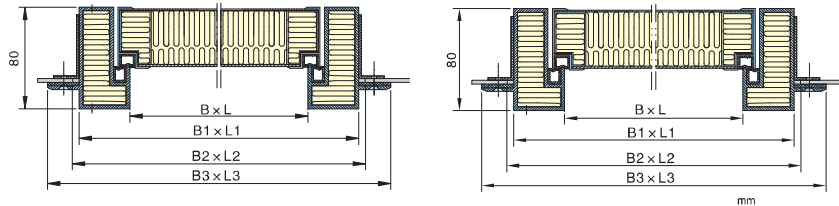
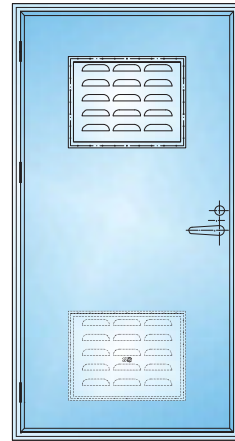

通孔尺寸 SIZE OF DOORWAY BXL	门框尺寸 FRAME SIZE B1XL1	围壁开孔尺寸 SIZE OF B.H. OPENING B2XL2	外形尺寸 SIZE OF OUTLINE B3XL3	重量 WEIGHT KG		其他选择项 OTHER OPTION
				不带通风栅 NO VENT 262WHL009A-00	带通风栅 WITH VENT 262WHL009T-00	
600X1650	680X1730	686X1736	730X1780	48.5	50.4	闭门器 DOOR CLOSER 定门器 DOOR STOPPER
700X1750	780X1830	786X1836	830X1880	56.5	58.4	

标记示例:

通孔尺寸为600X1650的右内开的铝质隔声门, 不带通风栅

铝质隔声门 600X1650-RI 262WHL009A-00

通孔尺寸为600X1650的左内开的带通风栅铝质隔声门

带通风栅铝质隔声门 600X1650-LI 262WHL009T-00



舰船装备 出类拔萃 海联产品 情联四海

### A0 隔声防火门 A0 SOUND & FIREPROOF DOOR

262WHL009F-00

此门隔声 35dB(A)  
SOUND-REDUCE VALUE 35dB

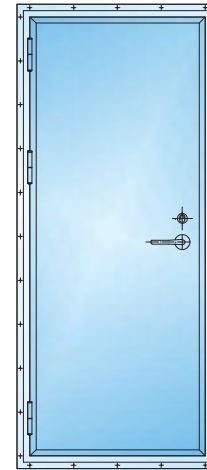

适应舱壁 SUIT FOR BULKHEAD

A	一道钢围壁	
B	一道钢围壁 一道装饰壁	
C	一道钢围壁 二道装饰壁	

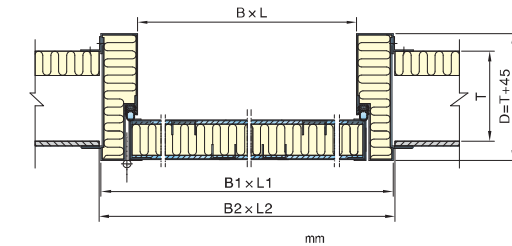

通孔尺寸 SIZE OF DOORWAY BXL	门框尺寸 FRAME SIZE B1XL1	围壁开孔尺寸 SIZE OF B.H. OPENING B2XL2	重量 WEIGHT KG
600X1650	700X1750	705X1755	107
650X1650	750X1750	755X1755	112
700X1650	800X1750	805X1755	117
600X1700	700X1800	705X1805	110
650X1700	750X1800	755X1805	115
700X1700	800X1800	805X1805	120
700X1750	800X1850	805X1855	123
800X1850	900X1950	905X1955	139

注: 重量(D=100mm)时计算结果。  
THE WEIGHT IS CALCULATED (AT D=100mm).

标记示例:

通孔尺寸为650X1700左外开一道钢围壁一道装饰壁的A0级隔声防火门

A0隔声防火门 (LO)-B-650X1700 262WHL009F-00





舰船装备 出类拔萃 海联产品 情联四海

### H120 防火门 H120 FIREPROOF DOOR

262WHL006H-00

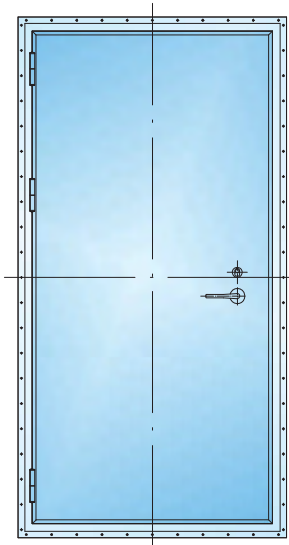

适应舱壁 SUIT FOR BULKHEAD

A	一道钢围壁	
B	一道钢围壁 一道装饰壁	
C	一道钢围壁 二道装饰壁	

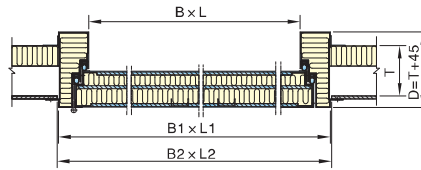

mm

通孔尺寸 SIZE OF DOORWAY BXL	门框尺寸 FRAME SIZE B1XL1	围壁开孔尺寸 SIZE OF B.H. OPNING B2XL2	重量 WEIGHT KG
600X1650	720X1770	725X1775	135
650X1650	770X1770	775X1775	141
700X1650	820X1770	825X1775	148
600X1700	720X1820	725X1825	138
650X1700	770X1820	775X1825	145
700X1700	820X1820	825X1825	152
700X1750	820X1870	825X1875	156
900X1900	1020X2020	1025X2025	191

注：重量为D=100mm时计算结果。

THE WEIGHT IS CALCULATED AT D=100mm .

标记示例：

通孔尺寸为650X1700的H120级左外开一道钢围壁一道装饰壁的H120防火门  
H120防火门 (LO)-B-650X1700 262WHL006H-00



舰船装备 出类拔萃 海联产品 情联四海

### A60 级带逃出口通风栅防火门 A60 CLASS FIREPROOF DOOR WITH ESCAPE & VENTILATION FENCE

262WHL005T-00

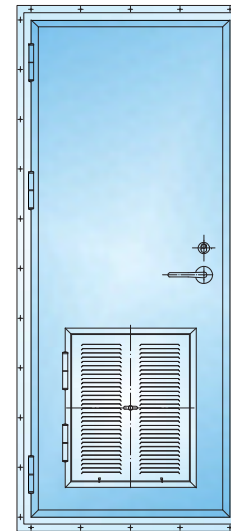

适应舱壁 SUIT FOR BULKHEAD

A	一道钢围壁	
B	一道钢围壁 一道装饰壁	
C	一道钢围壁 二道装饰壁	

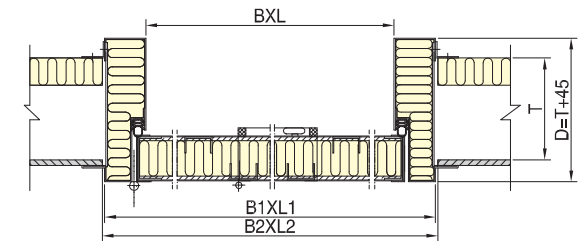

mm

通孔尺寸 SIZE OF DOORWAY BXL	门框尺寸 FRAME SIZE B1XL1	围壁开孔尺寸 SIZE OF B.H. OPNING B2XL2	重量 WEIGHT KG
600X1650	700X1750	705X1755	115
650X1650	750X1750	755X1755	120
700X1650	800X1750	805X1755	125
600X1700	700X1800	705X1805	117
650X1700	750X1800	755X1805	123
700X1700	800X1800	805X1805	128
700X1750	800X1850	805X1855	132
900X1850	1000X1950	1005X1955	158

注：重量 D=100mm时计算结果。

THE WEIGHT IS CALCULATED AT D=100mm .

标记示例：

通孔尺寸为650X1650左外开一道围壁一道装饰壁的A60级带逃出口通风栅防火门  
A60级带逃出口通风栅防火门 A60(LO)-B-650X1650 262WHL005T-00



舰船装备 出类拔萃 海联产品 情联四海

## 液压滑动式水密门 HYDRAULIC SLIDING WATERTIGHT DOOR

262WHL094-00  
(符合CB/T3007-2000)

本产品用于船舶水线以下的水密分隔壁上的门，一般用于机舱与轴隧间，机舱与锅炉间、主机舱与辅机舱间等。产品能够满足钢质海船入级与建造规范规定和SOLAS。

产品能在门的两面进行液压和手动关闭或开启，并可根据客户要求在上甲板设手动液压操纵手柄。

IT IS WATERTIGHT DOOR FOR BULKHEAD BELOW WATERLINE, WHICH IS USUALLY USED BETWEEN ENGINE ROOM AND SHAFT TUNNEL, OR BETWEEN ENGINE ROOM AND BOILER ROOM, OR BETWEEN ENGINE ROOM AND STEERING GEAR ROOM, ETC. IT COMPLIES WITH CLASS RULES FOR SEA GOING SHIP AND SOLAS.

THIS DOOR CAN BE POWER AND MANUALLY OPERATED FROM BOTH SIDES OF DOOR, AS WELL AS, HAND OPERATION COULD BE PROVIDED ON UPPER DECK IF NEED.

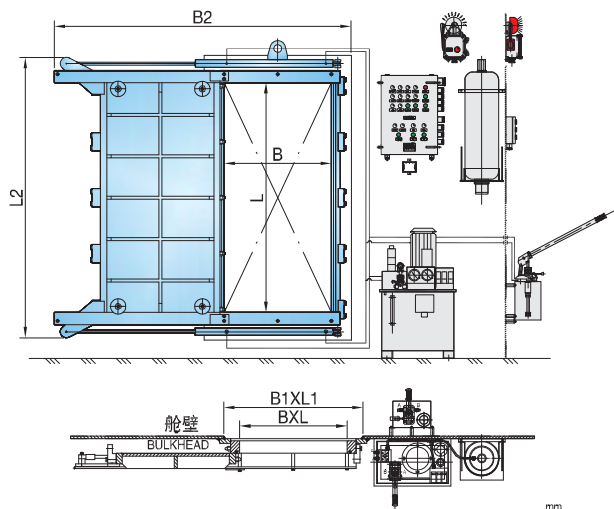

通孔尺寸 SIZE OF DOORWAY BXL	围壁开孔尺寸 SIZE OF B.H. OPENING B1XL1	外形尺寸 SIZE OF OUTLINE B2XL2	开向 OPENING DIRECTION	重量 WEIGHT KG
600X1200	800X1400	1720X1480	左开 L	765
700X1400	900X1600	1920X1680		872
800X1800	1000X2000	2120X2080	右开 R	1020
900X1900	1100X2100	2320X2180		1100
1000X2000	1200X2200	2520X2280		1230
1200X2000	1400X2200	2920X2280		1350

标记示例：

通孔尺寸为700X1400mm，左开液压滑动水密门

液压滑动水密门 700X1400-L 262WHL094-00



舰船装备 出类拔萃 海联产品 情联四海

## A60 液压滑动式水密门 A60 HYDRAULIC SLIDING WATERTIGHT DOOR

262WHL073-00

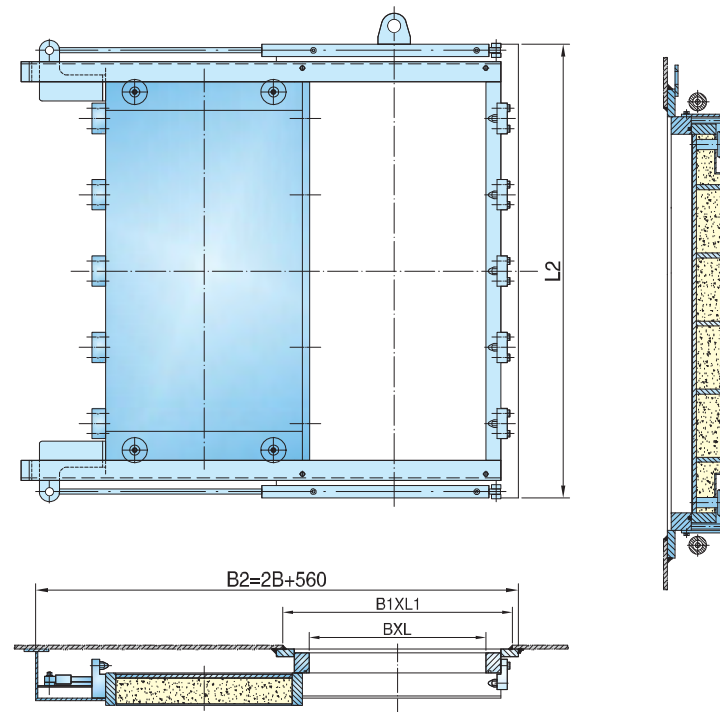

通孔尺寸 SIZE OF DOORWAY BXL	围壁开孔尺寸 SIZE OF B.H. OPENING B1XL1	外形尺寸 SIZE OF OUTLINE B2XL2	开向 OPENING DIRECTION	重量 WEIGHT KG
600X1200	800X1400	1760X1500	左开 L	870
700X1400	900X1600	1960X1700		990
800X1800	1000X2000	2160X2100	右开 R	1100
900X1900	1100X2100	2360X2200		1210
1000X2000	1200X2200	2560X2300		1350
1200X2000	1400X2200	2960X2300		1510

标记示例：

通孔尺寸为700X1400，左开A60液压滑动水密门

A60液压滑动水密门 A60-700X1400-L 262WHL073-00



舰船装备 出类拔萃 海联产品 情联四海

液压铰链式水密门  
HYDRAULIC HINGED WATERTIGHT DOOR

262WHL100-00

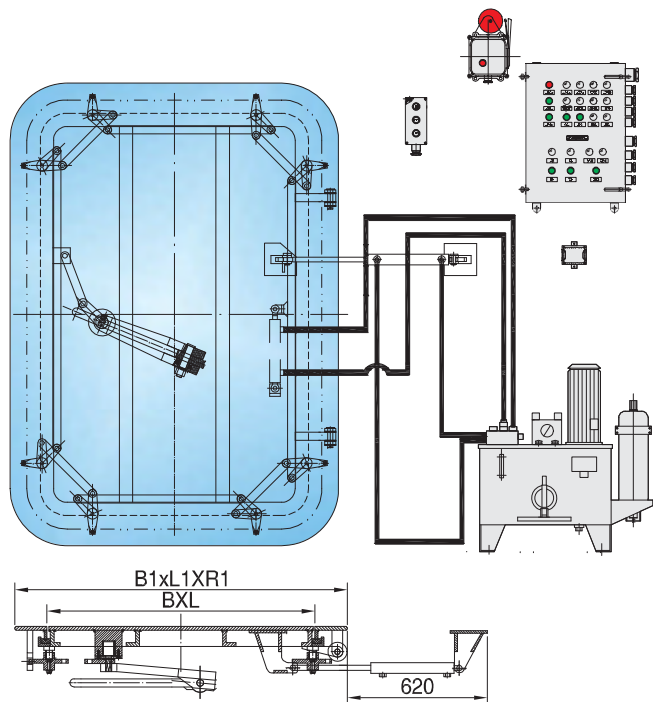

通孔尺寸 SIZE OF DOORWAY BXL	围壁开孔尺寸 SIZE OF B.H. OPENING B1XL1XR1	外形尺寸 SIZE OF OUTLINE B2XL2XR2	开向 OPENING DIRECTION	重量 WEIGHT KG
600X1000	840X1240XR220	840X1240XR220	左开 L	375
600X1100	840X1340XR220	840X1340XR220		391
600X1200	840X1440XR220	840X1440XR220	右开 R	410
700X1200	940X1440XR220	940X1440XR220		429
800X1200	1040X1440XR220	1040X1440XR220		450
900X1200	1140X1440XR220	1140X1440XR220		476

标记示例:

通孔尺寸为700X1200,左开液压铰链式水密门

液压铰链式水密门 700X1200-L 262WHL100-00



舰船装备 出类拔萃 海联产品 情联四海

A0 电梯层门(旁开双折)  
A0 LANDING DOOR FOR ELEVATOR (TWO PANELS SIDE)

262WHL071-00

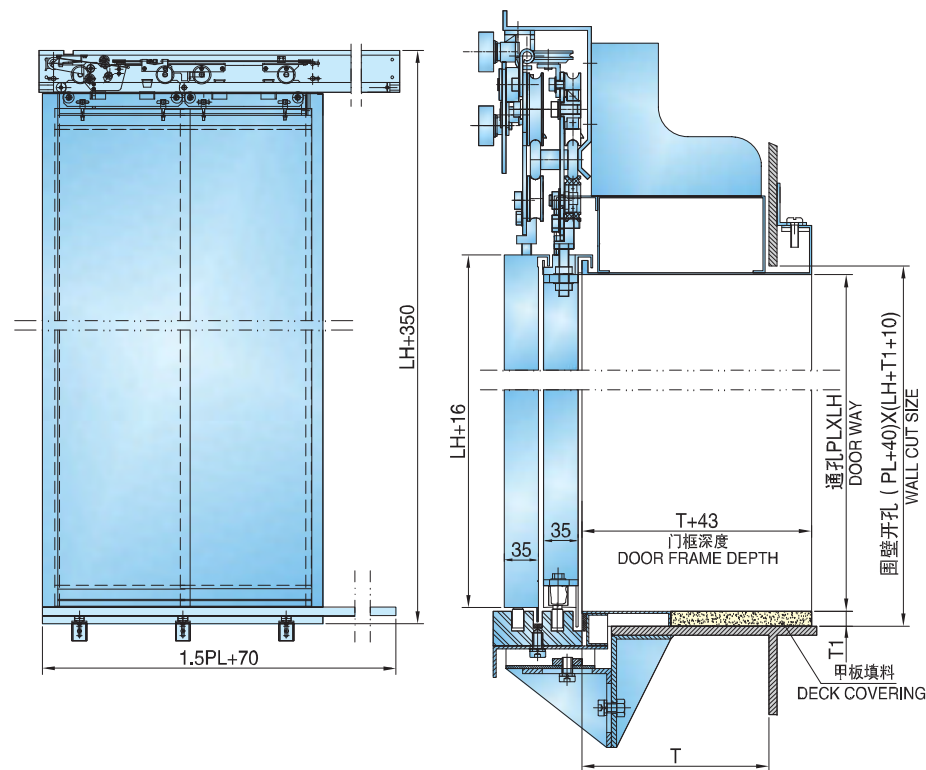

本门最大尺寸 1800X2300 mm.  
THE MAXIMUM SIZE IS 1800X2300mm.

标记示例:

通孔尺寸为PLXLH=1000X2000, T为190的左开式A0电梯层门(旁开双折)

A0电梯层门旁开双折 A0-1000X2000-190L 262WHL071-00



舰船装备 出类拔萃 海联产品 情联四海

**A0 电梯层门(中分)**  
**A0 LANDING DOOR FOR ELEVATOR(CENTRE)**

262WHL072-00

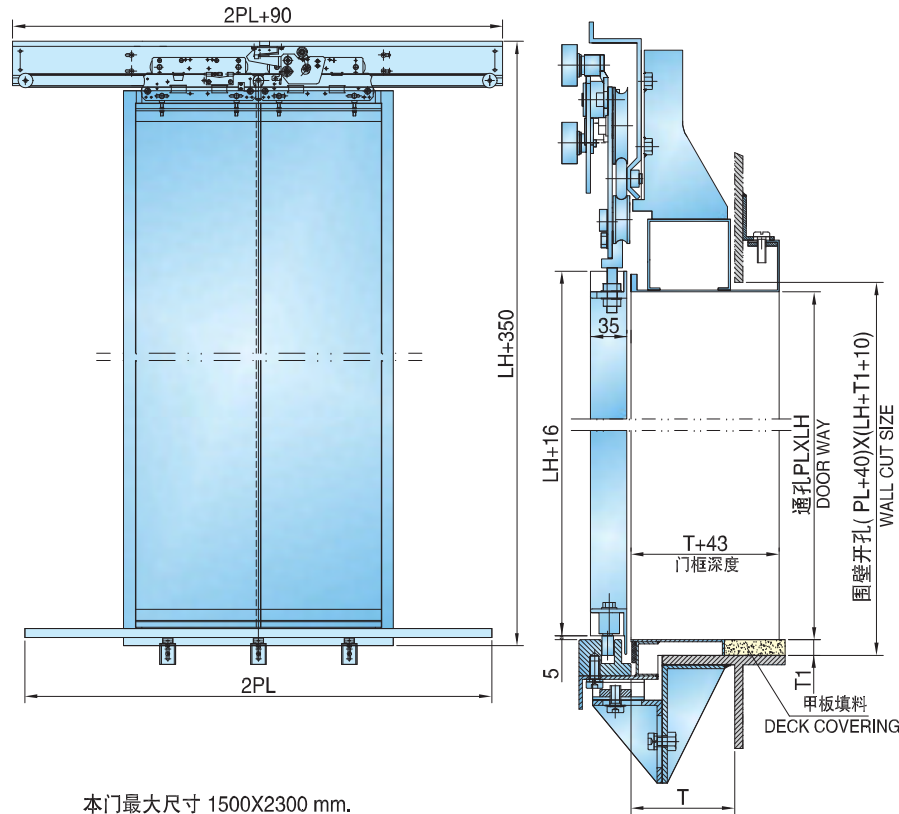

本门最大尺寸 1500X2300 mm.  
THE MAXIMUM SIZE IS 1500X2300mm.

标记示例:

透孔尺寸为  $PL \times LH=1000 \times 2000$ , T为100的A0电梯层门(中分)

A0电梯层门中分 A0-1000X2000-100 262WHL072-00



舰船装备 出类拔萃 海联产品 情联四海

**船用舷窗**  
**SIDE SCUTTLES FOR SHIPS**

GB/T 14413-1993

适用于海洋船舶和舰艇,也可用于内河船舶。  
USED FOR SEA-GOING SHIP AND WARSHIP, ALSO COULD BE USED FOR INLAND SHIP.

名称 NAME	形式 TYPE	透光尺寸 SIZE OF CLEAR D mm	开启方式 OPENING TYPE		安装方式 INSTALL TYPE	材料组合代号 MATERIAL CODE		风暴盖开启 固定方式 DEADLIGHT RETAINING METHOD	玻璃 GLASS	适用范围 APPLICATION SCOPE
			开式 OPENING	固定式 FIXED		螺栓式 BOLTED	焊接式 WELDED			
重型 HEAVY	A	200 250 300 350 400	左开式 (L)	固定式 FIXED (N)	螺栓安装 BOLTED (B)	112	212	挂钩式 HOOK TYPE (G)	透明 TRANSPARENT (Y1)	海船舱壁甲板或干舷甲板以下,满载水线以上允许舷侧开口部位,且要求水密和气密处所。
			右开式 (R)							
中型 MEDIUM	B		共铰链式 (S)	固定式 FIXED (N)	焊接安装 WELDED (W)	112	212	棘爪式 PAW TYPE (J)	磨砂 FEROSTED (Y2)	客船舱壁甲板或干舷甲板以上的舷边或上层建筑的端部。非客船干舷甲板上第一层上层建筑两侧和端部。
			222			222				
轻型 LIGHT	C	左开式 (L)	固定式 FIXED (N)	焊接安装 WELDED (W)	220	210			客船舱壁甲板或干舷甲板上第一层和以上各层上层建筑的侧面和后端部,非客船干舷甲板上第一层上层建筑以上围壁侧面和后端部。	
		330			220					
		450	右开式 (R)			110	230			

材料组合代号 MATERIAL CODE

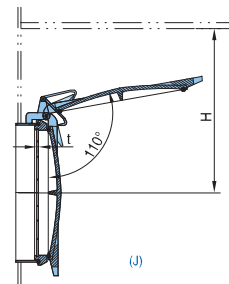

型式 TYPE	安装方式 INSTALL TYPE	材料 MATERIAL				材料组合 MATERIAL CODE
		主窗框 MAIN FRAME	窗缘框和玻璃压条 GLASS HOLDER AND RETAINER	风暴盖 DEADLIGHT		
A	螺栓式 BOLTED	铜 BRASS (1)	铜 BRASS (1)	钢 STEEL (2)	钢 STEEL (2)	112
	焊接式 WELDED	钢 STEEL (2)	钢 STEEL (2)	钢 STEEL (2)	钢 STEEL (2)	212
B	螺栓式 BOLTED	铜 BRASS (1)	铜 BRASS (1)	钢 STEEL (2)	钢 STEEL (2)	112
	焊接式 WELDED	钢 STEEL (2)	钢 STEEL (2)	钢 STEEL (2)	钢 STEEL (2)	212
C	螺栓式 BOLTED	铝 ALUMINIUM (3)	铝 ALUMINIUM (3)	钢 STEEL (2)	钢 STEEL (2)	220
	焊接式 WELDED	钢 STEEL (2)	钢 STEEL (2)	钢 STEEL (2)	钢 STEEL (2)	212

透光尺寸 CLEAR LIGHT SIZE D	200	250	300	350	400	450
舷窗中心与天花板最小距离 MIN.DISTANCE FROM CENTER OF SIDE SCUTTLE TO CEILING H	棘爪式 PAW (J)	350	400	450	500	580
	挂钩式 HOOK (G)	选用者自定 BY DESIGNER				

